



Regular-Route Bus Stop Design Guide

Table of Contents

INTRODUCTION	1
BUS STOP POSITION	4
○ Far side	5
○ Near side	6
○ Mid-block	7
○ Across from	8
○ In-lane bus stop	9
○ In-lane bus stop in a single travel lane	10
○ Pull-out bus stop	11
○ Pull-out bus stop with an on-street bike lane	12
TRAVEL LANE WIDTH.....	13
○ Non-Curbside.....	13
○ Curbside	14
○ Bus-Only Lane	15
BUS STOP ZONE DESIGN	16
○ Bus stop vehicle zone - in the street	17
○ Bus stop clear zone - behind the curb	24
○ Bus stop sign	28

Table of Contents

○ Accessible boarding area	29
○ Bus stops without sidewalks.....	31
○ Back door area	34
○ Shelters and pedestrian access route (PAR).....	35
○ Amenities and street furniture	41
○ Bike and scooter parking at bus stops.....	43
BUMPOUTS/CURB EXTENSIONS AND BUS STOPS	45
○ In-lane bus stop on a bumpout.....	45
○ Pull-out bus stop before/after a bumpout.....	47
○ Bumpouts at non-bus stop corners only.....	49
BUS STOPS AND BIKE FACILITIES	51
○ Bus stop bike lane mixing zone.....	52
○ Floating bus stop.....	53
○ Shared bike-bus stop	55
○ Bike facility on another street	57
PULL-OUT BAYS ON HIGH SPEED ROADS.....	58
TOPICS FOR FUTURE STUDY.....	60

Table of Contents

APPENDIX A: SUMMARY TECHNICAL SPECS.....	61
APPENDIX B: GLOSSARY OF TERMS	70
APPENDIX C: MERGE ZONE FIELD TEST	73
APPENDIX D: SHARED STOP CASE STUDY	78

List of Figures

- **Figure 1** An example of great bus stop design 2
- **Figure 2** Another example of great bus stop design 3
- **Figure 3** Bus stop positions: near side, far side, mid-block and across from 4
- **Figure 4** Across from bus stops can be near side or far side, but not in the intersection 8
- **Figure 5** Pull-out and In-lane bus stops 9
- **Figure 6-8** Single through travel lane contexts with bus stops 10
- **Figure 9** Preferred pull-out stop configuration with on-street bike lane 12
- **Figure 10** Bus stop and bike lane with ambiguous passing space 12
- **Figure 11** Preferred non-curbside travel lane width 13
- **Figure 12** Acceptable non-curbside travel lane width 13
- **Figure 13** Preferred curbside travel lane width 14
- **Figure 14** Acceptable curbside travel lane width 14
- **Figure 15** Image of a bus-only lane 15
- **Figure 16** Illustration of the zones in the street and behind the curb for far side and near side pull-out stops 16
- **Figure 17** Summary bus stop zone lengths for each stop position 17
- **Figure 18** Breakdown of bus stop vehicle zone lengths 20
- **Figure 19** Bus stop zone length required for pull-out stops 21
- **Figure 20** Bus stop zone length required for in-lane stops and stops on a bumpout 22
- **Figure 21** Bus stop zone length required for mid-block, pull-out stops 23
- **Figure 22** The bus stop clear zone, behind the curb 24
- **Figure 23** Clear zone and door zones at bus stops with common Metro Transit buses 26
- **Figure 24** Metro Transit regular route bus fleet size with door zones 27
- **Figure 25** Bus stop sign and bus stop pole installation 28
- **Figure 26** Accessible boarding area (ADA pad) 29
- **Figure 27** Bus boarding and alighting area and accessible bus shelters, ADA Standards 30
- **Figure 28** Accessible boarding area concrete pad dimensions 30

List of Figures

○ Figure 29 Example of bus stop without sidewalks or APS.....	31
○ Figure 30 Street-level accessible boarding area with connecting path	32
○ Figure 31 Example street-level accessible boarding area	32
○ Figure 32 Curb-level boarding area with curb ramp, connecting to an existing sidewalk across the street	33
○ Figure 33 Example of curb-level bus stop improvement and sidewalk connection to a curb ramp	33
○ Figure 34 Preferred paved front through back door zone	34
○ Figure 35 Separate paved back door carriage walk	34
○ Figure 36 Bus stop clear zone with shelter location options	36
○ Figure 37 Shelter configurations in the bus stop clear zone	37
○ Figure 38 Standard Metro Transit shelter types	40
○ Figure 39 Clear zone and other street furniture	42
○ Figure 40 Where to park near a downtown bus stop.....	44
○ Figure 41 Where to park near a neighborhood bus stop.....	44
○ Figure 42 Where to park near a rail station	44
○ Figure 43 Where parking is prohibited	44
○ Figure 44 In-lane bus stop sited on a bumpout with appropriate length	46
○ Figure 45 Pull-out bus stop before/after a bumpout, shown for 40 ft. and 60 ft. buses	48
○ Figure 46 Bumpouts at non-bus stop corners only	50
○ Figure 47 Bus stop and a bus bike mixing zone.....	51
○ Figure 48 Example of a bus bike mixing zone on Chicago Ave S at E 32nd St.	51
○ Figure 49 Floating bus stop	53
○ Figure 50 A floating bus stop on the University of Minnesota Twin Cities campus	53
○ Figure 51 Shared bike-bus stop	55
○ Figure 52 Shared bike-bus stop on Washington Ave at Marquette	56
○ Figure 53 Closed bay pull-out stop for high speed roadways	59

List of Figures

- **Figure 54** Open bay pull-out stop for high speed roadways 59
- **Figure 55** Verify which signs and transit poster inserts are needed with Metro Transit Information61
- **Figure 56** PDF image of the Metro Transit standard bus stop sign CAD file 62
- **Figure 57** Clear zones with 3-door and MCI buses 63
- **Figure 58** Corner number system for far side, near side, and mid-block bus stops 64
- **Figure 59** Corner number system for across from bus stops 65
- **Figure 60** An accessible boarding area concrete pad installation in a grass boulevard with room for an advertisement bench 66
- **Figure 61** An accessible boarding area (ADA pad) concrete pad installation to connect the sidewalk to the curb over a wide boulevard 67
- **Figure 62** An accessible boarding area concrete pad installation requiring a sidewalk. In this situation, the nearest existing sidewalk was approximately 25 ft. from the bus stop location 68
- **Figure 63** Acceleration/deceleration analysis for a pull-out bay 69
- **Figure 64** Simulated bus stops outside Heywood Garage 73
- **Figure 65** Measurements on sidewalk 73
- **Figure 66** Summary of near side scenarios tested74
- **Figure 67** Summary of far side scenarios tested 75
- **Figure 68** Screenshots showing a 60' bus testing a 40' merge zone a near side stop and a 60' bus testing a 40' merge zone at a far side stop76
- **Figure 69** Screenshot showing a 60' bus testing a 20' merge zone (too short) for a near side stop and failing 77
- **Figure 70** Screenshot showing a 60' bus testing a 10' merge zone (too short) for a far side stop and failing 77
- **Figure 71** Shared bike-bus stop plans for Washington Ave at Marquette 78
- **Figure 72** Observational volume of transit riders (ons + offs) and people on bikes 79
- **Figure 73** Shared bike-bus stop on Washington Ave. at Marquette, labeling the bike facility, landscaping zone/shelter, and sidewalk 79

Introduction

Why does Metro Transit need this guide?

The Metro Transit Regular-Route Bus Stop Design Guide is a tool to help Metro Transit and partners deliver environmentally sustainable transportation choices that link people, jobs, and community conveniently, consistently, and safely.¹ Providing transit service starts with the bus stop, where many riders first access the Metro Transit system. Every bus stop has unique site characteristics, which can make designing a consistent bus stop zone challenging. This Design Guide aims to outline best practices for bus stop design,² which can be integrated into roadway, development, or other projects that disturb the bus stop zone.

How to use this guide

This Guide is a resource developed by Metro Transit for municipalities, roadway authorities, property owners, developers, technical staff, and community members to use when partnering with Metro Transit to design and site high-quality bus stops and passenger waiting environments.

The bus stop is where people access the Metro Transit system and includes more than the area where riders get on and off at the bus stop sign. Designers siting a bus stop should consider the following:

- How do people walking and rolling get to the stop?
- How does the bus driver negotiate the roadway configuration and other vehicles to serve the stop?
- How do riders waiting for the bus engage with the local context?

Much of the content of this Guide is intended to apply when designing or improving a bus stop, and is not intended to be strict standards, but to inform design decisions within the site context. However, the Americans with Disabilities Act (ADA) information for designing accessible boardings areas and access routes referenced in this guide are standards that should be followed.

¹ metrotransit.org/mission-statement

² Bus rapid transit projects and stations are considered separately from this guide and generally include a package of transit enhancements, which add up to faster trips and enhanced rider experience.

Introduction

Figure 1 An example of great bus stop design



Grand Ave. at Pascal St., St. Paul

Introduction

Figure 2 An example of a great bus stop with shelter



Lyndale Ave. S. at 26th St., Minneapolis

Bus Stop Position

Bus stop position

Bus stop position is the location of the bus stop relative to the intersection or within a block. Types of bus stop positions include far side (just after an intersection), near side (just prior to an intersection), mid-block (away from an intersection), and across from (at a T-intersection).

Figure 3 Bus stop positions: near side, far side, mid-block and across from

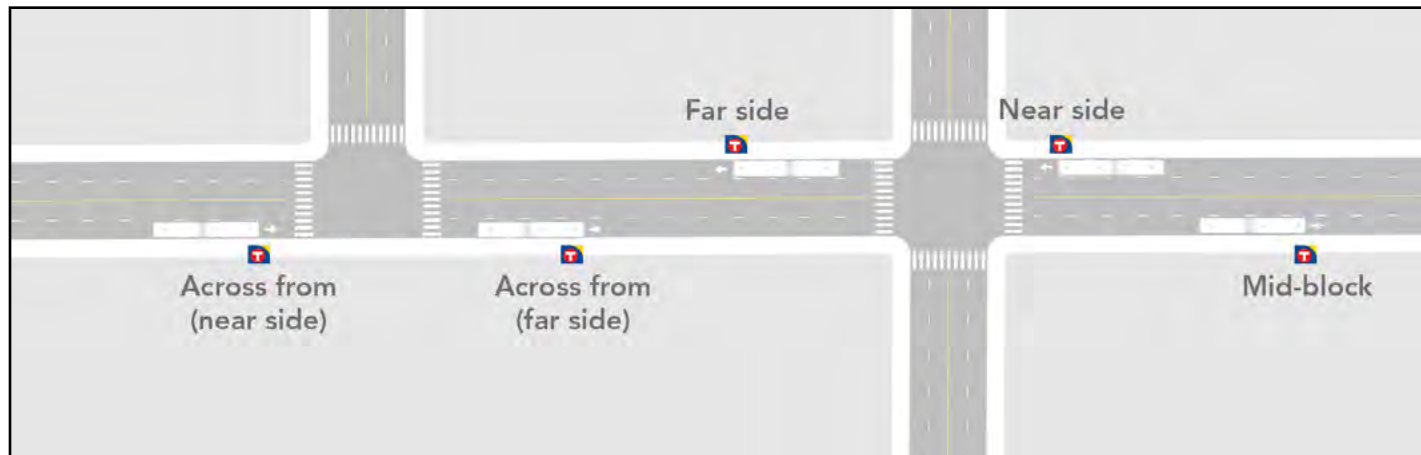

Bus Stop Position

Far side

Far side bus stops are located after the intersection (in the direction of travel). Far side stops, after a tight right-turn, may require additional length to maneuver to the curb.

Advantages:

- Far side pull-out stops allow bus drivers to use the space in the intersection to merge into the bus stop zone, providing the shortest total bus stop zone length for pull-out stops.
- At stop sign controlled or uncontrolled intersections, appropriately designed far side stops do not block sightlines between people walking across the intersection and people in vehicles, minimizing the multiple threat crash risk.³
- At signal-controlled intersections, the red signal phase facilitates bus reentry, stopping only one time and enabling faster travel times.
- On two-way streets, high volumes of right-turning vehicles can be accommodated with less conflict.

Disadvantages:

- Some riders may be tempted to cross the street in front of the bus after alighting.
- A far side stop at a stop sign controlled intersection would require the bus to make two stops.
- Far side stops require timely snow clearance of the boarding area. Unlike near side stops, far side stops do not provide space in the intersection if the loading area is blocked by snow windrows.
- There is a potential for rear-end collisions on high speed roads without appropriate bus stop zone design. Intersections may be blocked if other vehicles park illegally in the bus stop zone, and a bus is forced to wait.

³ In a multiple threat conflict, the person crossing could be at risk if one vehicle in the closest lane of travel yielded, but a vehicle in the second travel lane (in the same direction) did not. This could occur on multiple lane two-way roadways, or on multiple lane one-way roadways. For more information, see Minnesota Department of Transportation Project Summary Report "Evaluation of Sustained Enforcement, Education, and Engineering Measures on Pedestrian Crossings," by Nichole Morris, University of Minnesota, (2019). mndot.gov/research/reports/2019/201929.pdf

Bus Stop Position

Near side

Near side stops are located in advance of the intersection (in the direction of travel). Near side stops (on a multi-lane roadway) should not be considered if the route turns left.

Advantages:

- Near side pull-out stops allow bus operators to use the space in the intersection to pull out of the bus stop zone.
- Pick up and drop off location is close to the intersection, enabling people to cross the street to destinations.
- Winter snow plowing, without corner clearing, can make access to the bus stop difficult. Near side stops enable bus drivers to pick up and drop off riders in the intersection if there is no other safe place to do so.

Disadvantages:

- At some locations, cars failing to properly yield may turn right in front of the bus, creating an unsafe situation.
- At uncontrolled or stop sign controlled intersections, near side stops could block sightlines between people walking and people in vehicles, reducing the likelihood of vehicles properly yielding to people crossing. Sightlines between people in vehicles to traffic control devices may also be impeded.
- At controlled intersections (both signal and stop sign), near side stops can cause the bus to stop twice (in the signal queue and at the bus stop), which may result in delay.
- Heavy volumes of right-turning vehicles can create conflict with near side stops.

Bus Stop Position

Mid-block

A mid-block stop is not located next to intersection. Mid-block stops are generally less desirable than near side and far side stops, because stops at intersections provide places for riders to cross the street to destinations. In certain instances, such as a mid-block destination and/or mid-block crossing, or a long distance between intersections, this type of stop position should be considered.

Advantages:

- Buses minimize interference of sightlines between people, vehicles, and traffic control devices.
- Mid-block stops can be located next to major destinations.

Disadvantages:

- Some riders may be tempted to cross the street unsafely, if no mid-block crossing is provided, after alighting. If riders are transferring, it may require a farther walk to transit service on adjacent streets.
- Does not provide a cross street to drop off riders, in the event the stop is windrowed by snow.
- A mid-block, pull-out stop requires the longest total bus stop zone, space which otherwise could be on-street parking spaces or other curb uses.

Bus Stop Position

Across from

Some bus stops are located at T-intersections. Bus stops that are labeled as across from are located at T-intersections along the approach that continues straight through the intersection. Across from bus stops should not be located in the intersection, but rather before (near side) or after (far side) the intersection. A bus stop located in the intersection would likely block a marked or unmarked crosswalk and could interfere with sightlines.

Disadvantages:

- Across from bus stops that are sited in the intersection can block a marked or unmarked crosswalk, and interfere in sightlines between people, vehicles, and traffic control devices.
- Across from stops do not provide a cross street to drop off riders, in the event the stop is windrowed by snow.

Figure 4 Across from bus stops can be near side or far side, but not in the intersection

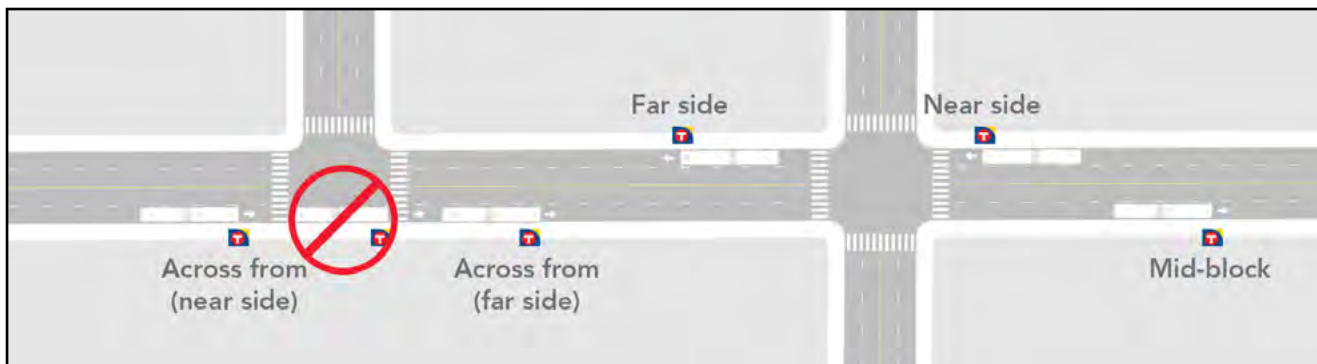

Bus Stop Position

In-lane bus stop

The position of a bus stop relative to the travel lane affects how easily buses can re-enter traffic flow and continue on their route. In-lane bus stops are located in a travel lane, allowing the bus to serve the stop and continue the route without having to merge out and then back into the travel lane. For more information on bumpouts, see the Bumpouts/curb extensions and bus stops section.

Advantages:

- In-lane bus stops allow the bus to avoid merging movements and can continue on its route as soon as all passengers have been served. Siting a bus stop in-lane can improve speed and reliability by eliminating the need for buses to exit the travel lane completely and then merge back into the flow of traffic.
- In-lane stops result in a more compact bus stop zone as compared to pull-out stops, preserving parking and other curbside uses.
- In-lane stops create more space for transit amenities that improve rider's experiences (shelter, bench, bike racks, lighting, greenery, etc.). In places with high pedestrian volumes, in-lane stops also provide more space for people walking.

Disadvantages:

- In-lane bus stops requires vehicles to pass the bus in an adjacent travel lane (if present) or queue behind the bus while it's serving the stop.

Figure 5 Pull-out and In-lane bus stops

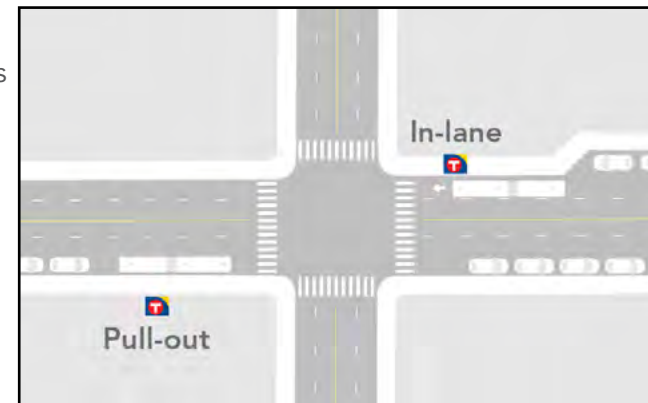

Bus Stop Position

In-lane bus stop in a single travel lane

In-lane bus stop in a single travel lane is an acceptable design. It may not be a preferred design at bus stops with longer dwell times or where there are traffic safety concerns based on sight distances, travel speeds, or traffic volumes. A pull-out bus stop may be preferred in contexts with medians longer than a half block.

Designers can evaluate strategies to mitigate safety concerns of drivers passing a dwelling bus. Roadway striping, lane width, medians or other forms of hardened centerline designs should communicate clearly whether road users may pass a dwelling bus or not.

See bus stops in single lane contexts in Figures 6-8.

Figures 6-8 Single through travel lane contexts with bus stops



In-lane stop with block length median and pull-out parking bays. Stinson Parkway at 19th Ave. NE, Minneapolis



In-lane stop without a median. Penn Ave. S. at W. 53rd St., Minneapolis



In-lane stop with short center median. Johnson St. NE at 22nd Ave. NE, Minneapolis

Bus Stop Position

Pull-out bus stop

A pull-out bus stop is located in a curbside lane (usually a parking lane or pull-out bay, signed as a bus stop), requiring the bus to merge out of and back into the travel lane in order to serve the stop.

Advantages:

- For stops with longer than average dwell times or layover functions (stops that serve high schools, stops that serve a route terminal or relief location), a pull-out stop can serve bus operators and riders well by reducing vehicle queues behind the bus.
- Siting a bus stop as a pull-out stop may be appropriate for local service on corridors with METRO Bus Rapid Transit service to keep BRT moving.

Disadvantages:

- Requires longer bus stop zone length than a bus stop located in-lane. The longer bus stop zone length also restricts on street parking.
- Reduces bus speed and reliability by requiring buses to merge out of and into the travel lane. Does not provide additional amenity space for riders as compared to stopping in-lane.

Bus Stop Position

Pull-out bus stop with an on-street bike lane

For roadways with on-street bike lanes and bus stops, the preferred pull-out bus stop should allow the bus to serve the stop without blocking the adjacent bike lane. This creates a straight path of travel for people on bikes. Bike lane dashed striping indicates where buses transition across the lane. The design creates a more predictable roadway for all users. The preferred pull-out bus stop design does not result in a dwelling bus that straddles travel or bike lanes, see Figure 9.

When buses pull out into a curbside bike lane narrower than the bus, the bus will overhang into the travel lane, and block the bike lane, creating ambiguity for road users, see Figure 10.

For more information on bike lane striping, refer to the Bus stops and bike facilities: mixing zone section.

Figure 9 Preferred pull-out stop configuration with on-street bike lane



Source: NACTO

Figure 10 Bus stop and bike lane with ambiguous passing space



W. 46th St. at Blaisdell Ave., Minneapolis

Travel Lane Width

Typically, Metro Transit buses are 11' wide including mirrors.

Non-Curbside

11' wide travel lanes are Metro Transit's preference for roadways where buses travel (not including gutter), see Figure 11. 10' wide travel lanes are acceptable for multiple travel lanes in the same direction or one way streets, see Figure 12.

Figure 11 Preferred non-curbside travel lane width

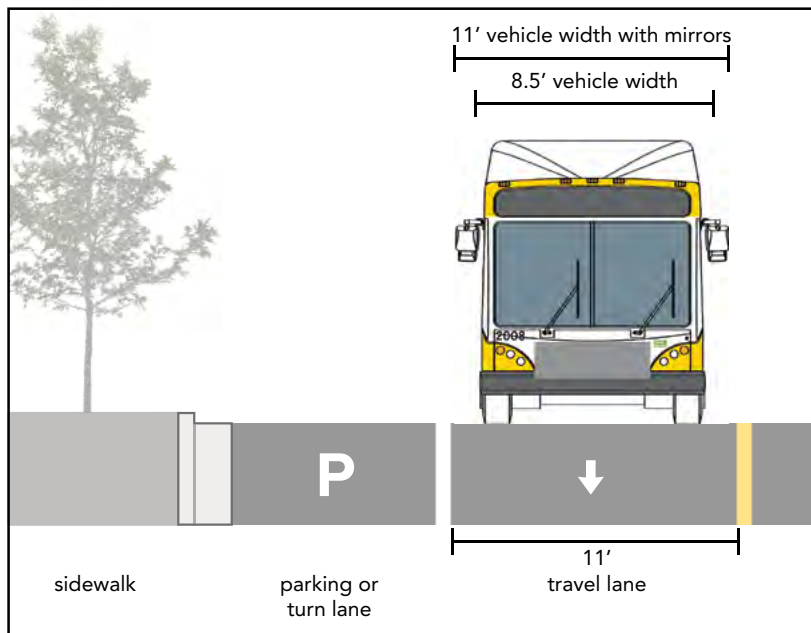
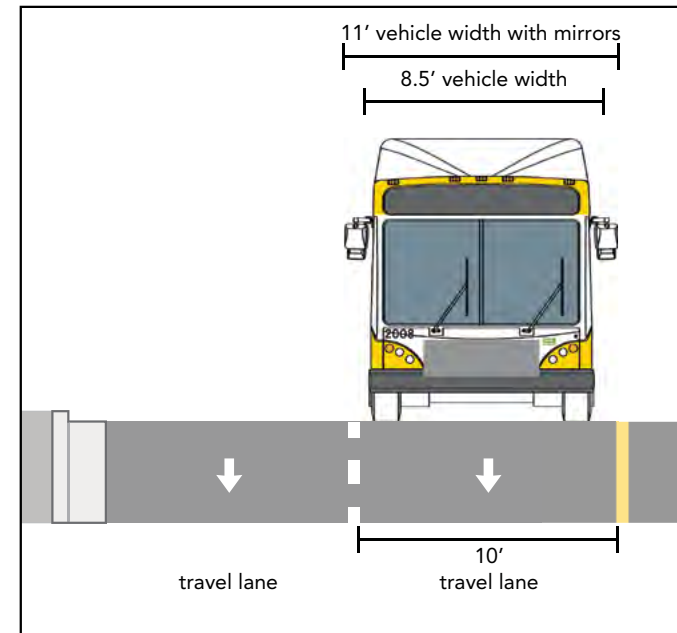

Figure 12 Acceptable non-curbside travel lane width



Travel Lane Width

Curbside

Generally, Metro Transit prefers 11' wide travel lanes. If the travel lane is curbside, an additional width of 2' measured to the face of curb (totaling 13') is preferred. An additional width of 1' (totaling 12') is acceptable. See Figures 13 and 14.

Figure 13 Preferred curbside travel lane width

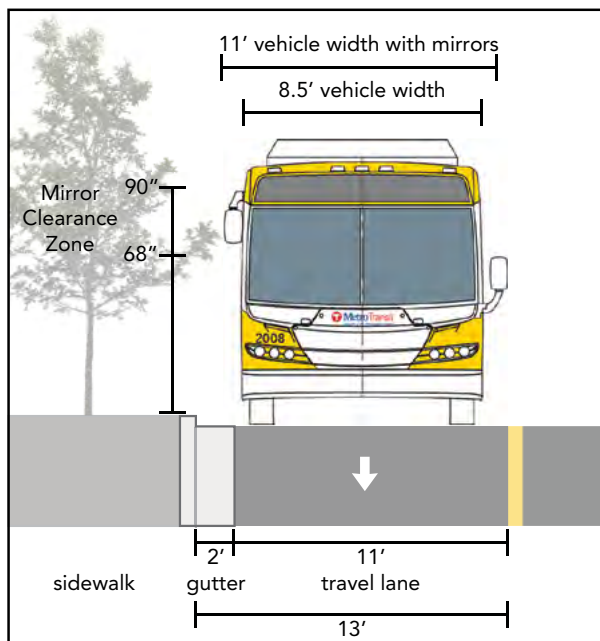
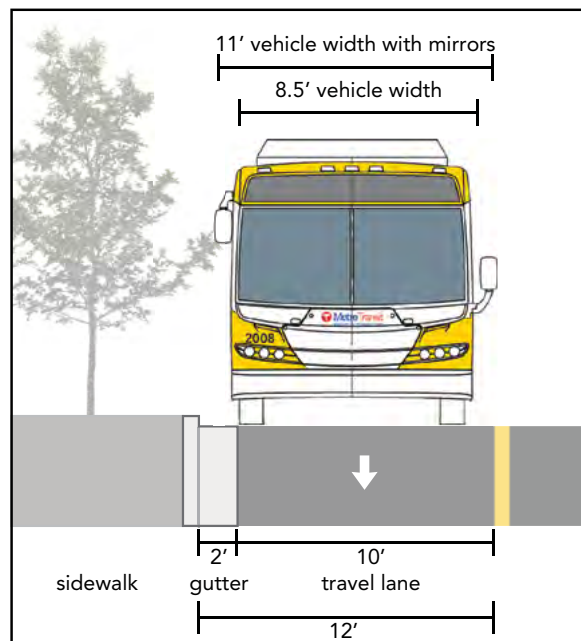

Figure 14 Acceptable curbside travel lane width



Travel Lane Width

Bus-Only Lane

11' wide travel lanes is Metro Transit's preference for bus-only lanes (not including gutter). If the lane is curbside, an additional width of 2' measured to the face of the curb (totaling 13') is preferred. If the bus-only lane is a contraflow lane, 13' is preferred.

Figure 15 Image of a bus-only lane



Chicago Ave. S., Minneapolis

Bus Stop Zone Design

The bus stop zone encompasses all elements of the bus stop, describing the bus stop vehicle zone, in the street, and the bus stop clear zone, behind the curb. The bus stop zone length is the total distance of curb (or edge of roadway) dedicated to the bus stop vehicle zone: setback from crosswalk, dwell zone, plus the merge zone for a pull-out stop. The bus stop clear zone is where buses stop, transit amenities are located, and riders wait to get on and off the bus.

Figure 16 Illustration of the zones in the street and behind the curb for far side and near side pull-out stops

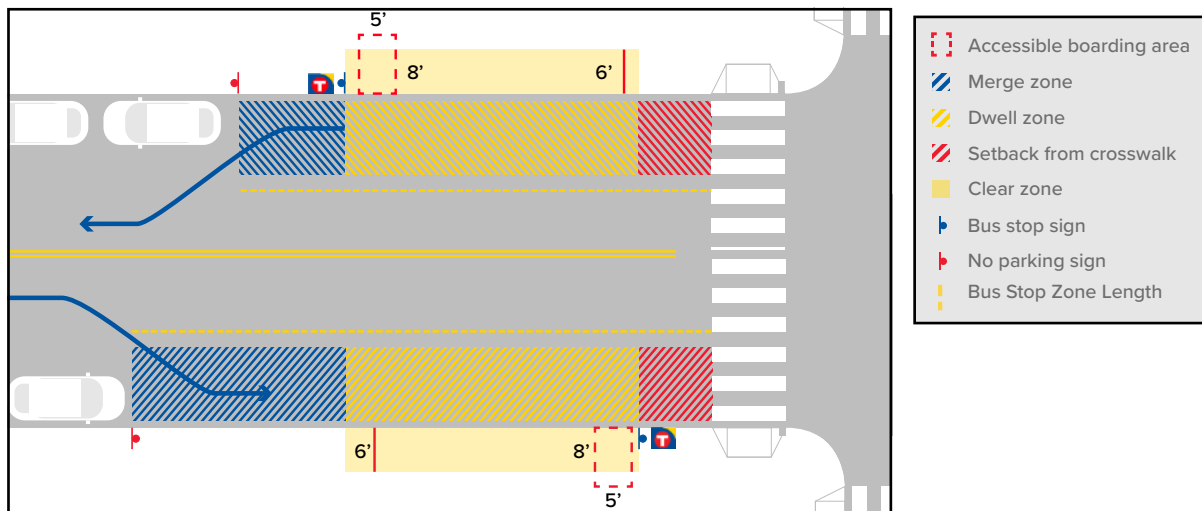

Bus Stop Zone Design

Bus stop vehicle zone – in the street

The total length of the bus stop vehicle zone is the sum of space needed for merging, dwelling, and a setback from crosswalk. For in-lane stops, the total zone length is the setback from crosswalk plus the dwell zone. More detailed design information for in-lane stops is included in the bumpout/curb extensions and bus stops section. For pull-out stops, the total zone length is the sum of the setback from crosswalk, dwell zone, and the merge zone. A summary of total zone length is shown in Figure 17 for each stop position and capacity for one or two buses.

Design projects provide opportunities to better model bus operations, and in specific circumstances, such as wide travel and parking lanes, a shorter bus stop zone may be acceptable. Coordinate with Metro Transit.

Figure 17 Summary bus stop zone lengths for each stop position

STOP POSITION	40' BUS	60' BUS	2 X 40' BUS	2 X 60' BUS
Near side pull-out	90'	110'	140'	180'
Far side pull-out	70'	90'	120'	160'
Mid-block pull-out	100'	120'	150'	190'
Near side in-lane	50'	70'	100'	140'
Far side in-lane	50'	70'	100'	140'
Mid-block in-lane	40'	60'	90'	130'

*Space for additional transit vehicle capacity should include 10' plus the length of the bus. Metro Transit bus sizes are either 40' or 60' long. A 60' bus is also known as an articulated bus. Mid-block bus stop zone lengths do not include a setback from crosswalk. If a crossing is present at a mid-block stop, include an additional 10' setback. Crossings can be marked (crosswalk) or unmarked (may include an accessible pedestrian ramp).

Bus Stop Zone Design

Merge zone

The merge zone is the space, in the street, needed to maneuver into and out of a curb lane at a pull-out stop. The merge zone is often designated by a No Parking Bus Stop sign, which denotes one end of the bus stop zone in a parking lane. To merge into a near side, pull-out stop, 40' is required in addition to the dwell zone. To merge out of a far side, pull-out stop, 20' is required in addition to the dwell zone, see Figure 19. Variations in street geometry and operation can require a longer merge zone, such as narrow travel lanes or a high-speed roadway (discussed in more detail in the Pull-out bays on high speed roads section and Appendix A).

In September 2020, a field test was conducted by Engineering & Facilities and Street Operations, with the goal to combine professional expertise, AutoTurn analysis, and field testing to confirm the space required for the merge zone. Using simulated near side and far side stops near Heywood Garage, the team tested 40' and 60' buses to arrive at the recommended lengths used in Figure 7 and Figure 8. Additional findings and documentation from the field test can be found in Appendix C.

Dwell zone

The dwell zone is the space, in the street, needed for a transit vehicle to stop at the curb, or edge of roadway, and perform dwell functions: rider boarding and alighting, fare collection, etc. The length of the dwell zone is equal to the length of the bus(es) serving the stop, which is often one bus and either 40 or 60'. If a bus stop requires two or more buses to serve the stop at the same time, the dwell zone would be the sum of the length of multiple buses plus 10' between each bus, to maintain independent movement. The front of the dwell zone is marked by the bus stop sign, see Figures 19-21.

Bus Stop Zone Design

Setback from crosswalk

The setback from crosswalk is a 10' distance between the dwell zone and a marked or unmarked crossing to preserve sightlines between people in vehicles and people walking, see Figures 16, 19, and 20. For near side stops, the setback from crosswalk is 10' between the crossing and the nose of bus. For far side stops, the setback from crosswalk is 10' between the tail of bus and the crossing. It is important for far side stops to maintain this setback so that the bus is not blocking the crossing while serving the bus stop. Mid-block stops do not require a setback from crosswalk unless a crossing is present. Crossings can be marked (crosswalk) or unmarked and may or may not include an accessible pedestrian ramp.

Bus Stop Zone Design

Vehicle zone lengths

Figure 18 Breakdown of bus stop vehicle zone lengths

STOP POSITION	TOTAL BUS STOP VEHICLE ZONE LENGTH	MERGE ZONE	DWELL ZONE AND BUS SIZE	SETBACK FROM CROSSWALK
Near side pull-out	90'	40'	40'	10'
	110'		60'	
Far side pull-out	70'	20'	40'	10'
	90'		60'	
Mid-block pull-out	100'	40' and 20'	40'	-
	120'		60'	
Near side in-lane	50'	-	40'	10'
	70'		60'	
Far side in-lane	50'	-	40'	10'
	70'		60'	
Mid-block in-lane	50'	-	40'	10'
	70'		60'	

*A crosswalk can be present within the merge zone for a mid-block stop however the front or rear of the bus should not block the crossing while serving the stop.

Bus Stop Zone Design

Pull-out stops

Figure 19 Bus stop zone length required for pull-out stops

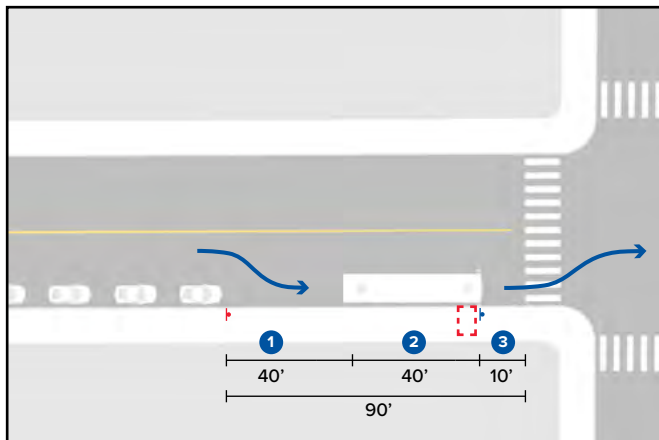

40' bus near side pull out

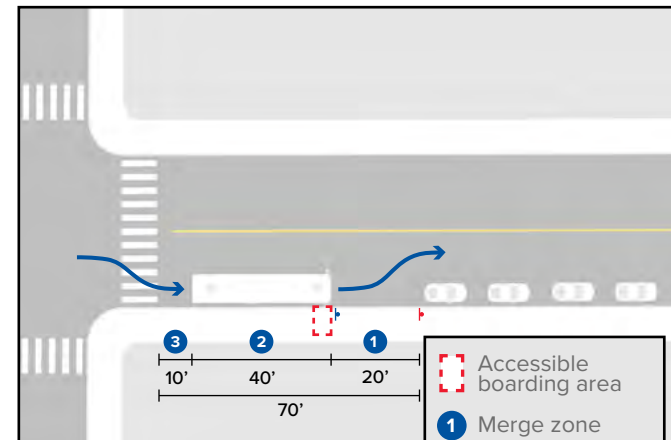

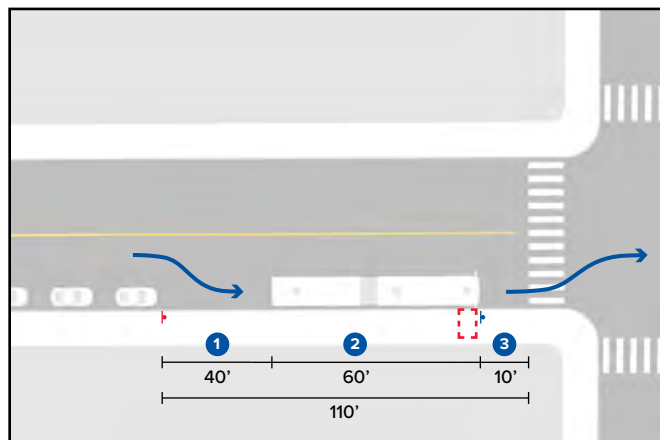

40' bus far side pull out

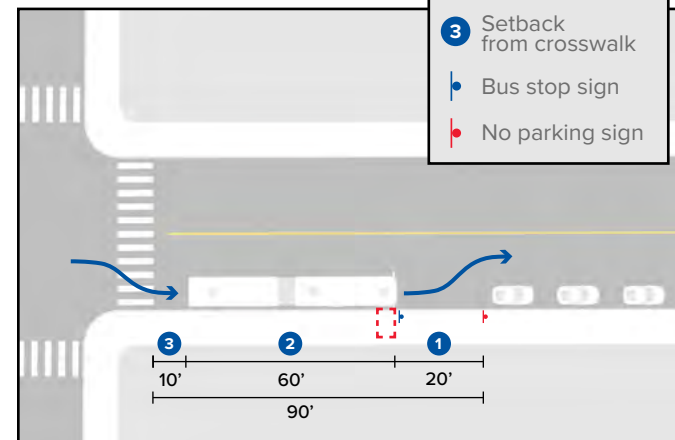

60' bus near side pull out



60' bus far side pull out

-  Accessible boarding area
- 1** Merge zone
- 2** Dwell zone
- 3** Setback from crosswalk
-  Bus stop sign
-  No parking sign

Bus Stop Zone Design

In-lane stops

Figure 20 Bus stop zone length required for in-lane stops and stops on a bumpout

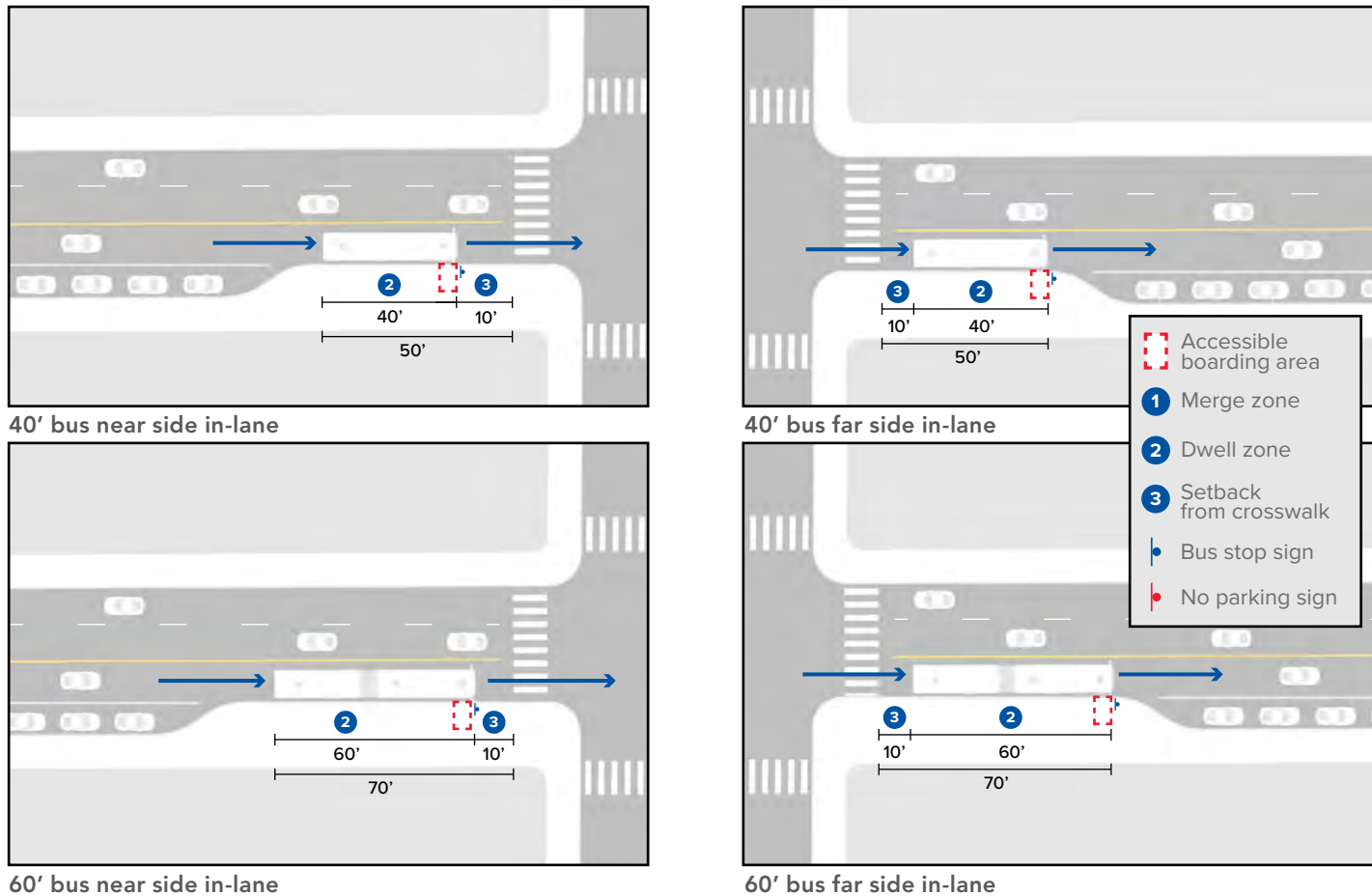

*Bumpouts must comfortably reach the back door when the bus serves the stop. Snow storage is also a consideration when designing bumpouts.

Bus Stop Zone Design

Mid-block stops

Figure 21 Bus stop zone length required for mid-block, pull-out stops

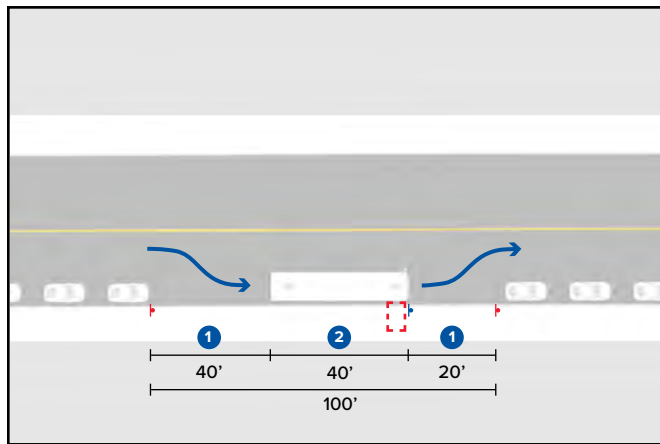

40' bus mid-block pull-out

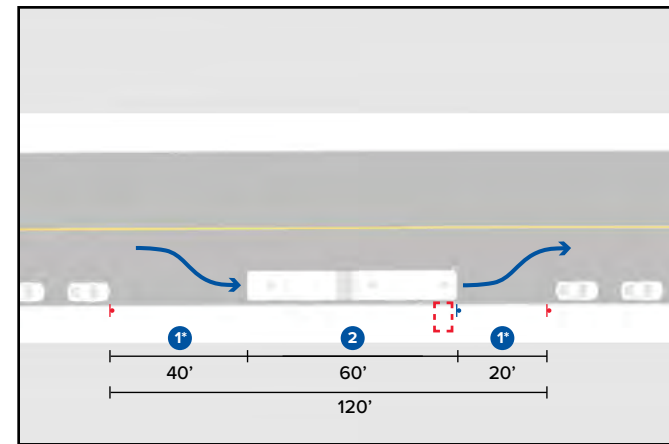

60' bus mid-block pull-out



Bus Stop Zone Design

Bus stop clear zone - behind the curb

Figure 22 The bus stop clear zone, behind the curb

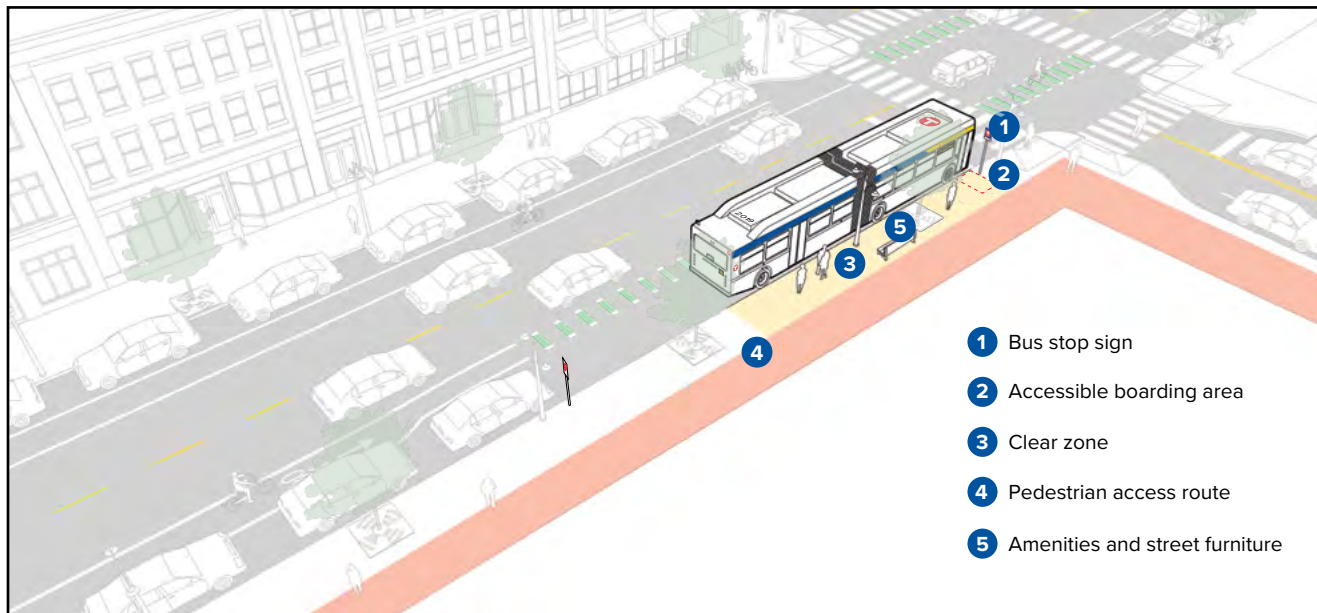

Graphic adapted from National Association of City Transportation Officials (NACTO) Transit Street Design Guide with permission for Metro Transit. Image delivered to Metro Transit 9/3/19.

Bus Stop Zone Design

Clear zone behind the curb

The clear zone, behind the curb, is where riders wait, queue, board, and alight the bus. The clear zone includes the bus stop sign, accessible boarding area, space for a bus shelter,⁴ and other streetscape amenities. The clear zone is 6' of clear space behind the curb, measured perpendicular to the roadway centerline, and free of vertical obstructions with the exception of the bus shelter, trash/recycling receptacles, benches, lighting fixtures, and columnar trees⁵ with a walkable surface, such as tree grates or turf grass. This helps ensure that transit riders exiting through the rear door can do so without obstruction or difficulty, see Figures 23 and 24. The length of the clear zone is generally the length of the bus serving the stop, unless multiple buses are scheduled to serve the stop concurrently. Pavers are discouraged in the clear zone as they can heave and become trip hazards. Additionally, Metro Transit shelters cannot be installed on pavers.

Common obstructions that should be avoided in the clear zone include raised landscaping beds and bike racks. See the Amenities and street furniture section for more detailed guidance. Adjacent development or other roadway construction projects can disturb the clear zone. The project should coordinate with Metro Transit for replacing the bus stop.

⁴ Metro Transit considers adding shelter at a bus stop with 30 or more average daily passenger boardings, as funding and maintenance resources allow. metrotransit.org/shelter-guidelines

⁵ Some street trees will require annual maintenance, such as trimming large branches to prevent interference with buses pulling into the bus stop.

Bus Stop Zone Design

Figure 23 Clear zone and door zones at bus stops with common Metro Transit buses

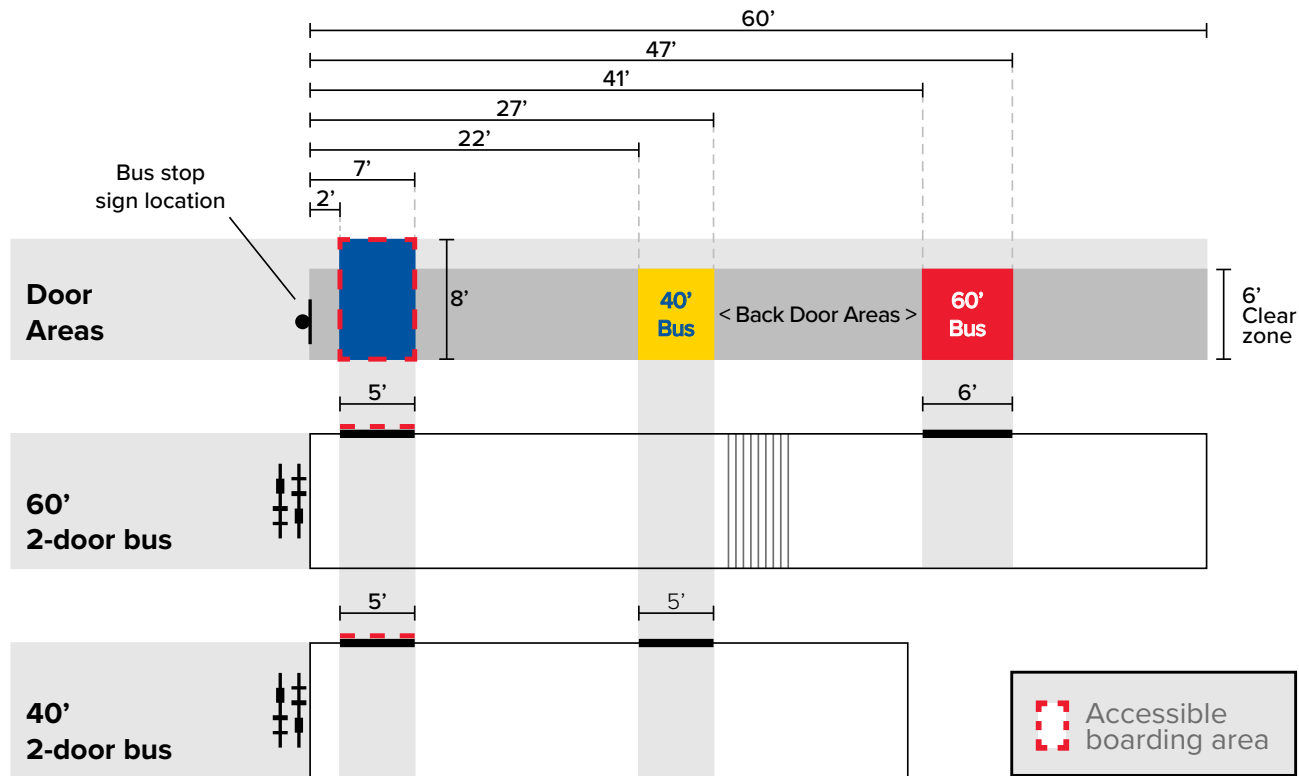

*Back door zones can be grass, but paved areas are recommended for busy bus stops.

Bus Stop Zone Design

Metro Transit’s bus fleet includes 40’ and 60’ buses. The graphics and chart include the clear area dimensions for the front and rear door zones, including the accessible boarding area.

	Front door zone	Rear door zone
40’ bus	2’-7’	22’-27’
60’ bus	2’-7’	41’-47’

Figure 24 Metro Transit regular-route bus fleet size with door zones

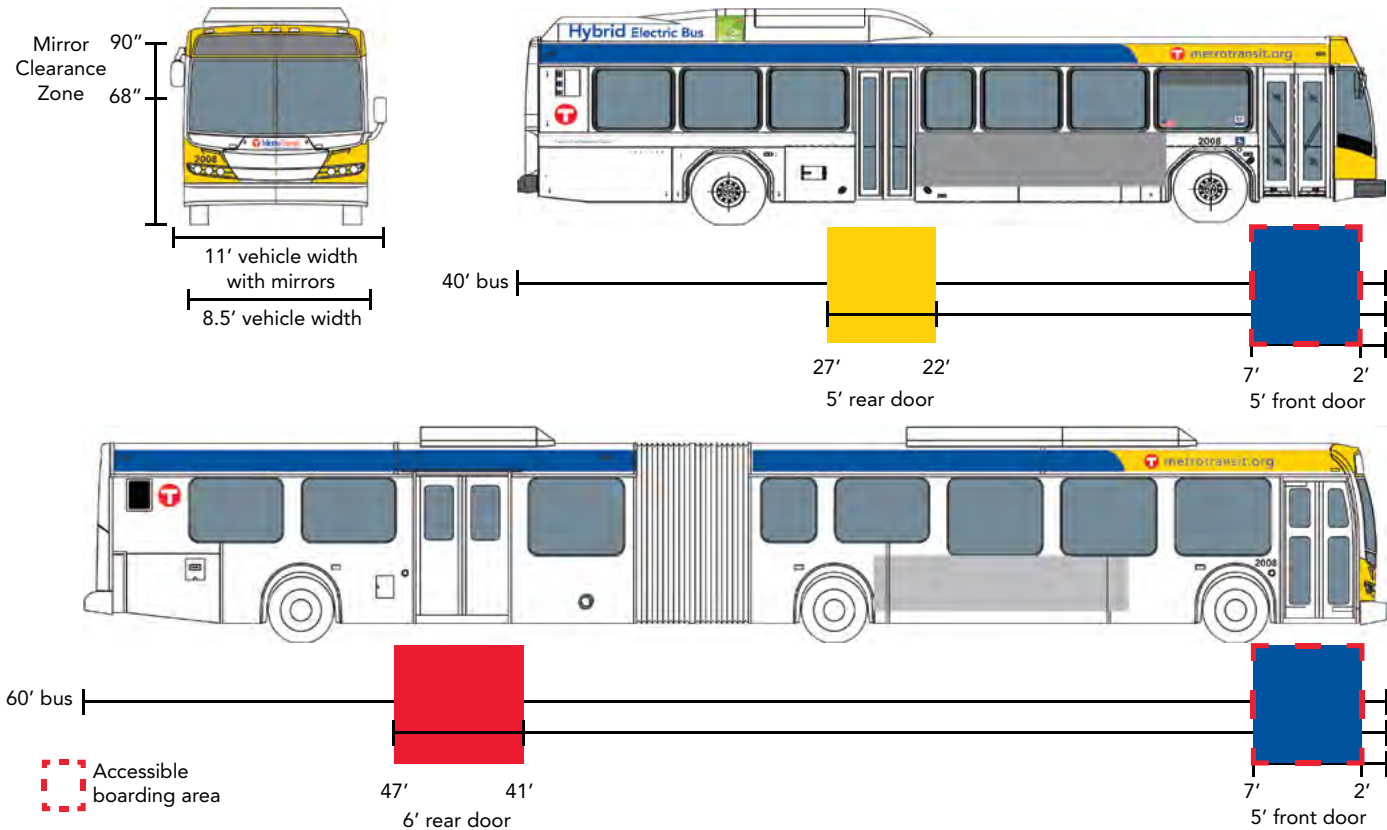

Bus Rapid Transit projects are considered separately from this guide and most BRT vehicles have 3 doors. See Appendix A for more information.

Bus Stop Zone Design

Bus stop sign

The bus stop sign indicates where bus drivers will stop, where riders will board and alight the bus, and is the anchor of the bus stop zone. The bus stop sign should be located at the front of the clear zone, adjacent to the accessible boarding area. Metro Transit bus stop signs are site specific and include the unique bus stop number, route number of bus routes serving the stop, and NexTrip information. The bus stop sign or shelter may also include map, schedule information, or real-time signs. Roadway reconstruction plans should use Metro Transit standard bus stop sign CAD file (dwg) for labeling bus stops.⁶ For more details on transit information at bus stops, refer to Metro Transit Transit Information and Guidelines for Transit Information at Bus Stops and Metro Transit Signage Standards for Public Facilities. A summary can be found in Appendix A.

Metro Transit and local roadway authorities should coordinate for pole placement and installation in the right-of-way. Pole location can be installed in pavement or turf grass, see Figure 35. Occasionally, bus stop signs are affixed to the bus shelter in the most challenging and constrained sites. Bus stop signs should be affixed to a pole specifically located to anchor the bus stop zone, which can be an existing regulatory sign. Sign poles should be sited 24 in. back from face of curb, to ensure no conflict with the bus mirror, see Figure 25.

⁶ metrotransit.org/shelter-design

Figure 25 Bus stop sign and bus stop pole installation



Bus Stop Zone Design

Accessible boarding area

The accessible boarding area (also known as the “ADA pad”) is a place where riders get on and off the bus at the front door, directly adjacent to the bus stop sign. This is also the space where bus drivers deploy the ramp for riders using mobility devices, such as a wheelchair. The accessible boarding area is a firm and stable surface, and “shall provide a clear length of 96 in. (8’), measured perpendicular to the curb or vehicle roadway edge, and a clear width of 60 in. (5’) minimum, measured parallel to the vehicle roadway,”⁷ as stated in the 2010 ADA Standards for Accessible Design, see Figure 27. “Parallel to the roadway, the slope of the accessible boarding area shall be the same as the roadway, to the maximum extent practicable. Perpendicular to the roadway, the slope of the accessible boarding area shall not be steeper than 1:48.”

The bus stop sign can be installed in concrete or grass, see Figure 28. Turf grass is acceptable for the back door zone, however it is not recommended for busy bus stops, see Figures 23 and 24. Examples of accessible boarding area installations are found in Appendix A.

⁷ [access-board.gov/prowag/technical.html#r309111-dimensions](https://www.access-board.gov/prowag/technical.html#r309111-dimensions)

Figure 26 Accessible boarding area (ADA pad)

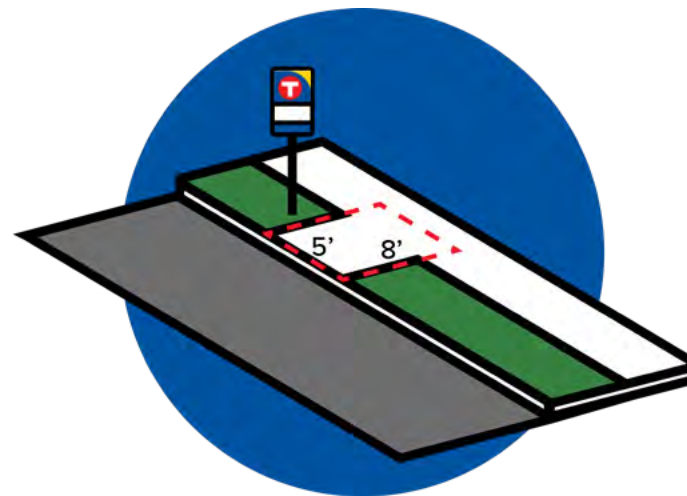

Bus Stop Zone Design

Figure 27 Bus boarding and alighting area and accessible bus shelters as shown in 810.2.2 and 810.3 of the 2010 ADA Standards for Accessible Design

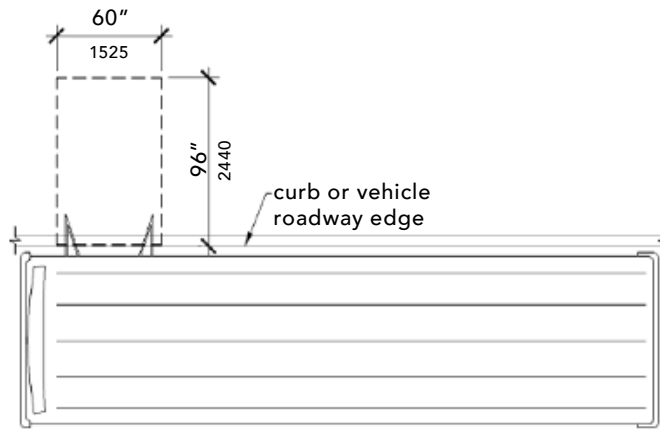

Figure from 810 Transportation Facilities chapter of the 2010 ADA Standards for Accessible Design.

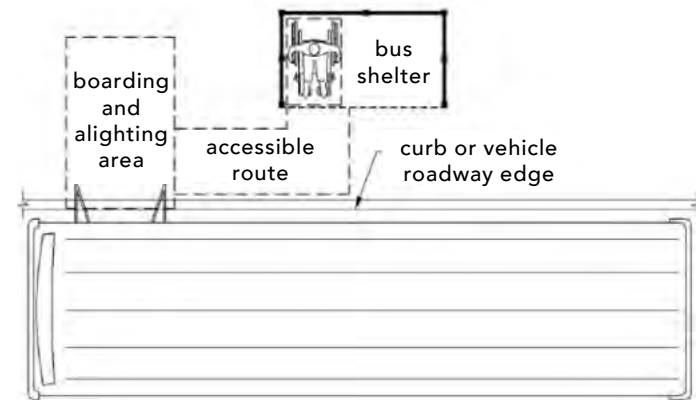
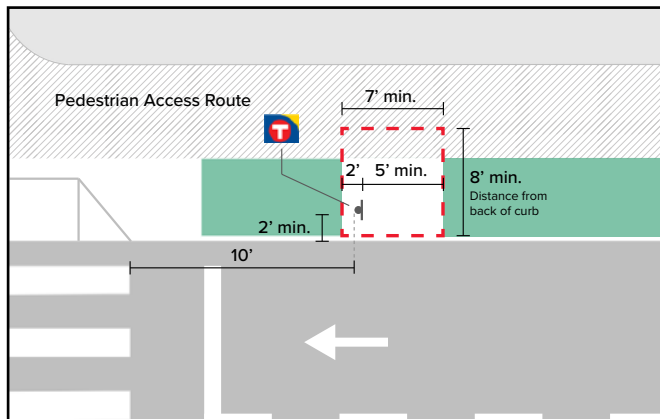
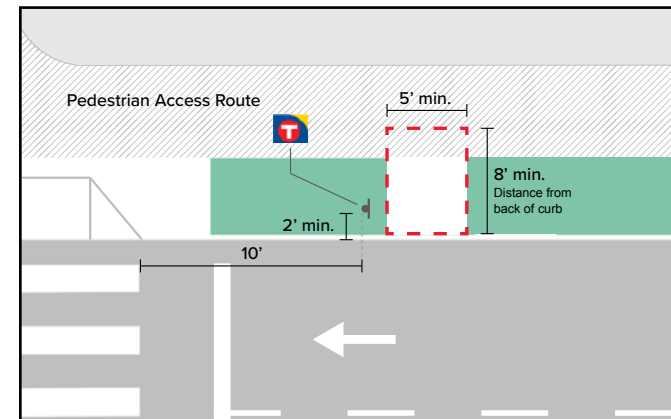

Figure from 810.3 Transportation Facilities chapter of the 2010 ADA Standards for Accessible Design.

Figure 28 Accessible boarding area concrete pad dimensions



Accessible boarding area with bus stop sign in concrete



Accessible boarding area with bus stop sign in grass

Bus Stop Zone Design

Bus stops without sidewalks

When siting a bus stop where no sidewalks are present, Metro Transit considers a variety of factors, including:

- Nearby destinations
- Roadway design, including: vehicle speeds, number of lanes, or available right-of-way
- Existing pedestrian infrastructure, which may include accessible pedestrian signals (APS) or non-adjacent sidewalks
- Planned pedestrian infrastructure
- Bus operations

Bus stop locations may be shifted to better access existing pedestrian infrastructure. In some circumstances, constructing an accessible boarding area that connects with the street or crosswalk may be recommended. While best practices would constitute a fully accessible pedestrian network, incremental solutions provide value for transit riders ahead of a dedicated pedestrian facility being constructed.

Figure 29 Example of bus stop without sidewalks or APS



Desoto St. and Mt. Vernon Ave., Maplewood

Bus Stop Zone Design

Street-level bus stop pad

For stops without a curb or adjacent sidewalk, a street-level boarding area outside of travel lane and shoulder can be an area of refuge for people waiting, walking or rolling to the stop. These boarding areas can be level with the roadway and paired with APS (accessible pedestrian signals).

Near side stop placement is recommended for curbless stop pad improvements to minimize the distance between the bus stop from the crossing.

Figure 30 Street-level accessible boarding area with connecting path

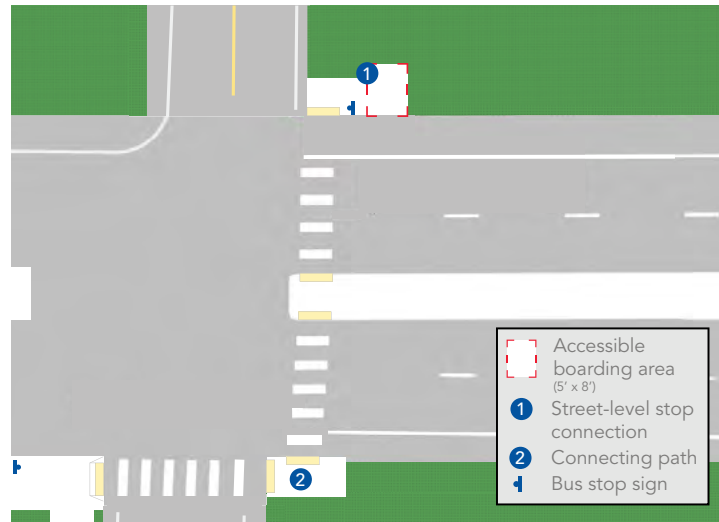

Figure 31 Example street-level accessible boarding area



Babcock Trail & 52nd St. E., Inver Grove Heights

Bus Stop Zone Design

Curb-level bus stop pad with curb ramp

For stops where there is a curb, but no pedestrian infrastructure adjacent to the stop, an accessible boarding area with a connection to a curb ramp is acceptable to connect with other pedestrian facilities. Figures 32 and 33 demonstrate a bus stop design that connects to an existing sidewalk across the street.

Figure 32 Curb-level boarding area with curb ramp, connecting to an existing sidewalk across the street

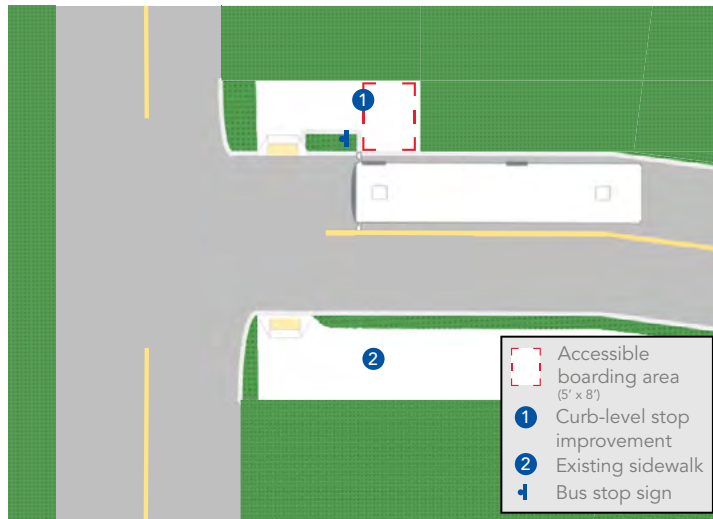

Figure 33 Example of curb-level bus stop improvement and sidewalk connection to a curb ramp



Londin Ln. and Burlington Rd., St. Paul

Bus Stop Zone Design

Back door area

The back door area is part of the clear zone. For most bus stops, a walkable area that is a natural surface, such as turf grass, is acceptable for the back door. Some bus stops may benefit from a paved back door, consider:

- High daily activity, especially alightings
- High bus ramp deployment
- Transfer point
- Proximity to high pedestrian traffic destinations, or near a crosswalk for far side stops

If paving the back door area, consider paving the entire zone from the T sign to the back door. This provides extra space for passenger queuing and space for a bench or future shelter. See Figure 34.

A separate paved back door area (carriage walk) can be appropriate when there are vertical obstructions (trees or poles) or green infrastructure goals. This design requires more precision for design review, construction, and project/field staff support. See Figure 35.

Figure 34 Preferred paved front through back door zone



Franklin Ave. E. at Franklin Station, Minneapolis

Figure 35 Separate paved back door carriage walk



Lyndale Ave. S. and W. 41st St., Minneapolis

Bus Stop Zone Design

Shelters and pedestrian access route

Metro Transit provides shelters at stops with high boardings to improve transit riders' comfort while waiting for the bus. To serve the most people, stops with at least 30 boardings per day are considered for a shelter if resources are available. Additionally, to serve transit riders who may especially benefit from a shelter, priority locations include stops near housing for people with disabilities, hospitals, healthcare clinics, social service providers, and major transfer points. Shelter lighting is prioritized for stops where there are higher boardings during the typical dark hours between sunset and sunrise.⁸ Shelter heating is considered if there are at least 100 boardings per day and when there are opportunities to efficiently bring power to the shelter. See Metro Transit's Shelter Placement Guidelines for more information.⁹

Bus rapid transit projects are considered separately from this guide and generally include a package of transit enhancements, which add up to faster trips and enhanced rider experience.¹⁰

Once a stop is identified for a shelter based on the guidelines, site factors such as available space, slope, and obstructions determine if a shelter can be located at a bus stop. Three possible shelter location options are shown in Figure 37. Other shelter locations may be explored in a unique or constrained site context. Bus shelters and other street furniture used by transit riders and others, such as benches, must be accessible, see Figure 27.

⁸ For most shelters, an electrical connection is required for light and heat. A few shelters serving Metro Transit bus stops have light powered by solar. To coordinate potential electrical connection, contact Metro Transit Engineering and Facilities.

⁹ metrotransit.org/shelter-guidelines

¹⁰ metrotransit.org/brt

Bus Stop Zone Design

Figure 37 Shelter configurations in the bus stop clear zone

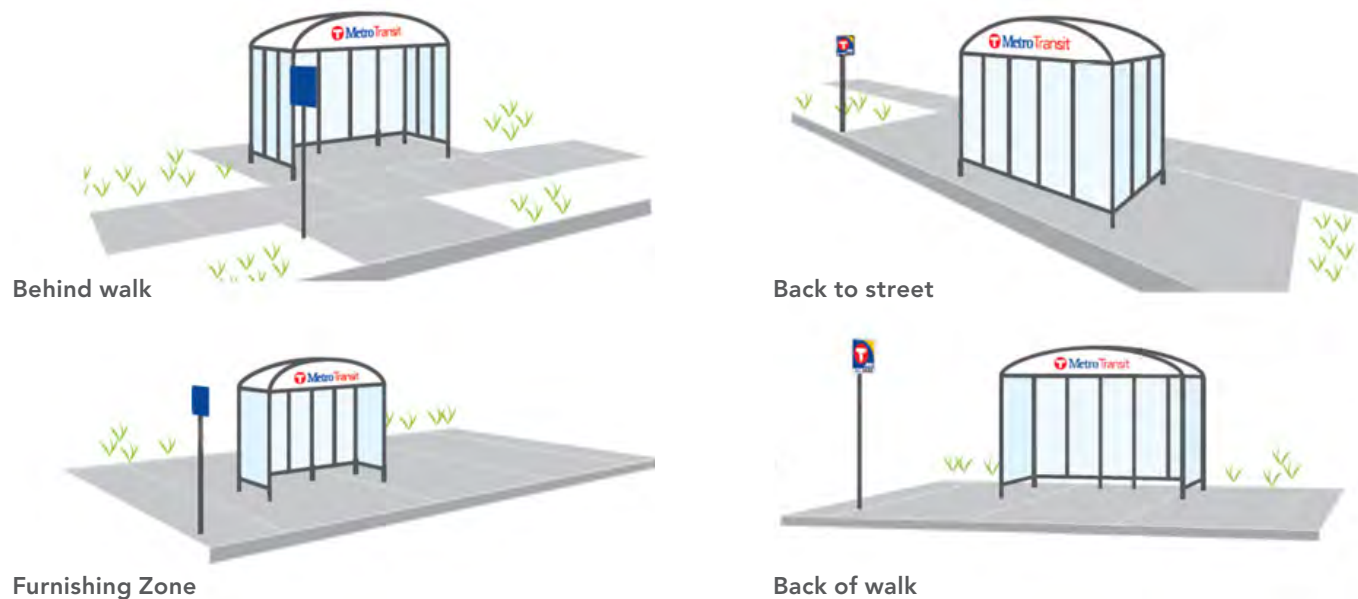

A shelter can be installed directly on existing sidewalk or on a concrete pad specifically poured for a shelter (not on pavers). Shelters can be installed open to street or back to street, in four different scenarios, see Figure 37. When installing a shelter on existing sidewalk, Metro Transit requires a minimum clearance of 4' wide pedestrian access route must be maintained as stated in the Proposed Accessibility Guidelines for Pedestrian Facilities in the Public Right-of-Way 2011 (PROWAG), see Figure 36. Some jurisdictions recommend a 5' or wider pedestrian access route around a shelter. A 6' wide pedestrian access route is preferred by Metro Transit.

Bus Stop Zone Design

Designers should consider a smaller shelter type if installation would create a choke point in the pedestrian access route. Metro Transit has five standard shelter types, all of which provide shelter, seating, and detailed transit information, see Figure 38.¹¹ Metro Transit also installs bronze shelters near historic buildings or places. Designers should consider how riders living with a mobility, vision, cognitive, or other impairment would navigate the space. Pedestrian access routes should be as direct as possible and avoid jogging around obstructions.

Clearance for maintenance and snow removal should be maintained around the shelter. Generally, a 4' clearance is preferred between the shelter and other vertical elements including buildings, retaining walls, fences, meters, utility boxes, etc. This allows Metro Transit to clear snow more easily with larger equipment. A constrained minimum of 18 in. clearance between the shelter and other vertical elements is acceptable, however designers should coordinate with Metro Transit Engineering and Facilities to analyze the site context. Shelters must be located a minimum of 18 in. from back of curb to ensure no conflict with bus mirrors.

Designers should consider sightlines between people walking and rolling, and people in vehicles when siting a shelter. If advertisement panels are included on a shelter, it should not block sightlines between riders and bus operators or obstruct the ability of Metro Transit police to see into the shelter.

Some Metro Transit bus stops are served by custom shelters or integrated waiting areas (designed as part of the building façade), which require an agreement and design that supports transit operations, rider experience, and meets all applicable ADA standards.¹² Interested property owners or developers should coordinate with Metro Transit Engineering and Facilities.

¹¹ metrotransit.org/shelter-design

¹² Bus stops with at least 30 demonstrated average daily boardings, and where site constraints prevent installing a standard Metro Transit shelter are good candidate locations for custom shelters or waiting areas. An agreement, executed by both parties, should include information about transit rider use, design, property owner maintenance responsibilities, and other terms.

Bus Stop Zone Design







In addition to the different shelter dimensions in Figure 38, a summary of clearances to consider when siting a shelter include:

- 18" clearance from back of curb (to avoid conflict with bus mirror),
- 18" minimum clearance from vertical elements (to enable technicians to complete maintenance), and
- 1' buffer from edge of standalone concrete pad to all sides of shelter (to ensure bolt installation does not crack concrete).¹³

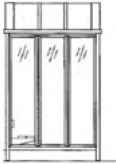
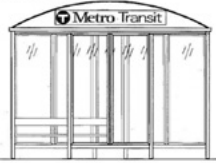
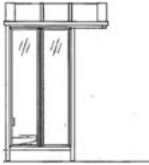
¹³ All proposed shelter installations should coordinate with Metro Transit Engineering and Facilities.

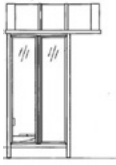
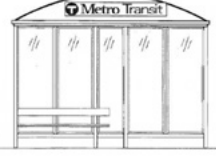
Bus Stop Zone Design

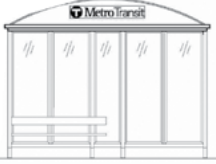
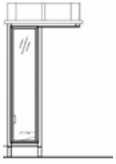
Figure 38 Standard Metro Transit shelter types

SHELTER TYPE & DIMENSIONS	SIDE ELEVATION	FRONT ELEVATION	CONCRETE SHELTER PAD DIMENSIONS
<p>Type C 6' deep and 12' long</p>			8' deep and 14' long
<p>Type D 4' deep and 8' long</p>			6' deep and 10' long
<p>Type E 4' deep and 12' long</p>			6' deep and 14' long
<p>Type F 2' deep and 12' long</p>			4' deep and 14' long
<p>Type G 2' deep and 8' long</p>			4' deep and 10' long

Bus Stop Zone Design

Amenities and street furniture

Lively streets often have other amenities and street furniture on or near the sidewalk that benefit transit riders and other people passing by. However, if placed in the bus stop clear zone, these amenities can become an obstruction for people getting on or off the bus. Most notably, street furniture should not block the pedestrian access route through the accessible boarding area or other door zones, see Figure 39.

Types of street furniture that should be located **outside** of the clear zone: landscaping boxes & planters, newspaper boxes, fire hydrants, utility poles, roadway signs, signal boxes, e-scooters, bikeshare bikes, bikeshare hubs, bike racks, café/patio seating, neighborhood or historical wayfinding, retail sandwich boards, valet podiums, and other street furniture.

Types of street furniture that should be located **inside** the clear zone: transit shelters, benches, trash/recycling receptacles, narrow/columnar trees in walkable grates, public art, and streetlights. Consult Metro Transit Engineering and Facilities for design and placement of transit shelters, public art, and other amenities in the bus stop clear zone.¹⁴

¹⁴ metrotransit.org/shelter-guidelines

Bus Stop Zone Design

Figure 39 Clear zone and other street furniture

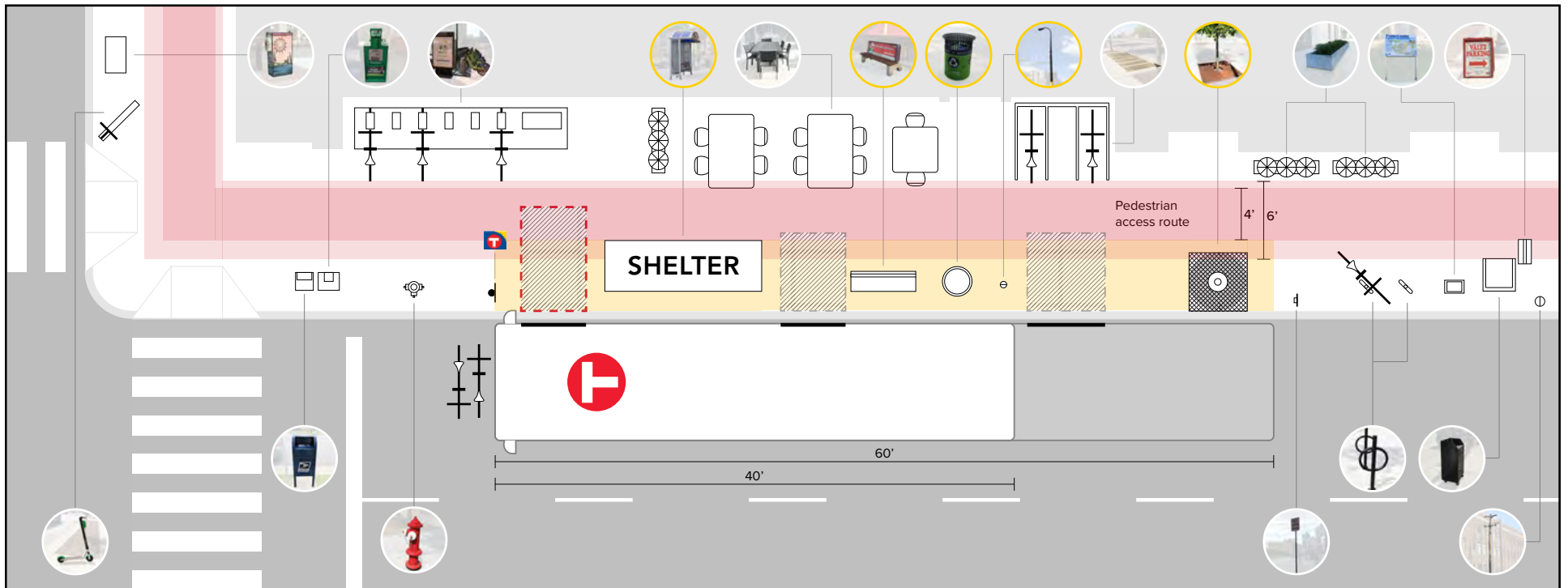

*There may be additional hidden utilities underneath the pavement. When installing a shelter, coordination between Metro Transit and public works staff is vital.

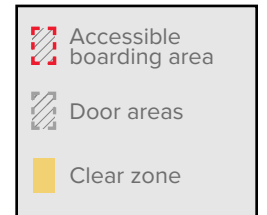

Bus Stop Zone Design

Bike and scooter parking at bus stops

The rapid growth in shared micromobility has introduced new ways to travel. Scooters and bikes can help riders get to/from bus stops. Users also need to know where to appropriately park these devices near a bus stop. Figures 40 and 41 show where to park near a downtown/high-activity and neighborhood bus stop. Don't park in the clear zone, the space along the curb where buses stop, see Figure 43. Parking in the clear zone could block riders accessing the front door or exiting through the rear door. It is important for users to take special care not to park in the accessible boarding area, where the ramp is deployed for transit riders using mobility devices.

Best options include parking around the corner from the bus stop (provided the other corner is not a bus stop), parking at bike racks or on a pole next to a legally parked car. However, these mobility options are changing rapidly and users should consult the City in which they are riding for the rules. Figure 42 shows where parking is permitted at METRO stations. Do not park on station platforms or ramps to the platforms. Do park at bike racks near stations.

Bus Stop Zone Design

Figure 40 Where to park near a downtown bus stop

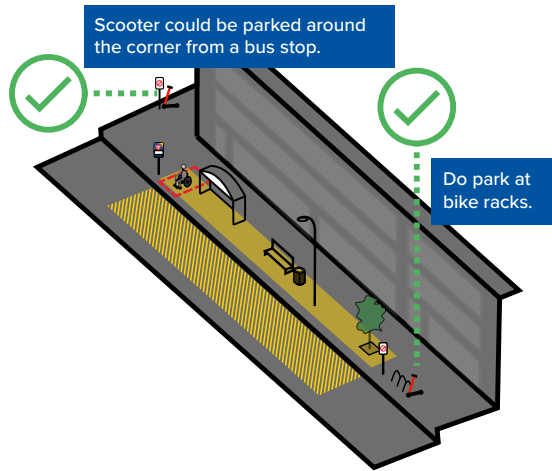

Figure 41 Where to park near a neighborhood bus stop

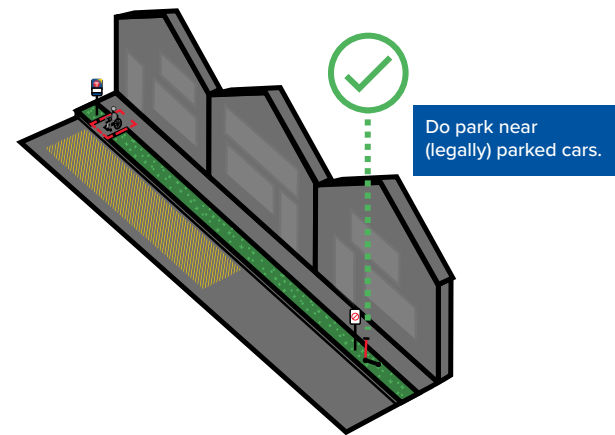

Figure 42 Where to park near a rail station

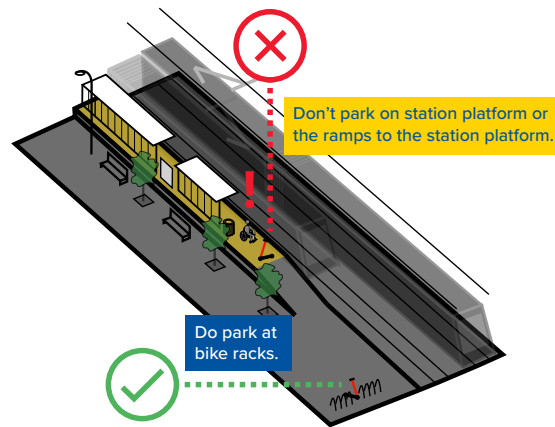
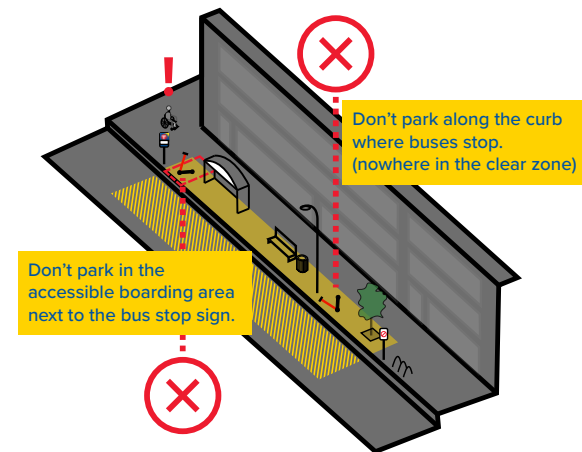

Figure 43 Where parking is prohibited



Bumpouts/curb extensions and bus stops

A curb bumpout is a strategy to improve safety for all road users, by extending the curb at a corner and narrowing the roadway width at intersections. Designers can consider three different scenarios when curb bumpouts¹⁵ are proposed at an intersection with bus stops or on transit streets.

In-lane bus stop on a bumpout

To locate an in-lane bus stop on a bumpout, designers must make the bumpout long enough to reach past the back door on buses that serve the stop, see Figure 44. The back door of a bus must meet the curb and should never open into a parking lane.

Advantages:

- In-lane bus stops, on a bumpout, create more space for transit amenities that improve riders' experiences (shelter, bench, lighting, greenery, etc.). In places with high pedestrian volumes, in-lane stops also provide more space for people walking.
- Bumpouts shorten the crossing distance and increase safety for people walking to and from transit.
- If the roadway has multiple travel lanes in each direction, other vehicles can pass a dwelling bus.
- Siting a bus stop in-lane can improve speed & reliability by eliminating the need for buses to exit the travel lane completely and then merge back into the flow of traffic.
- In-lane stops result in a more compact bus stop zone as compared to pull-out stops, preserving parking and other curbside uses.

Disadvantages:

- Other vehicles using the roadway may queue behind dwelling bus.

¹⁵ Another name for a bumpout is a curb bulb.

Bumpouts/curb extensions and bus stops

Figure 44 In-lane bus stop sited on a bumpout with appropriate length

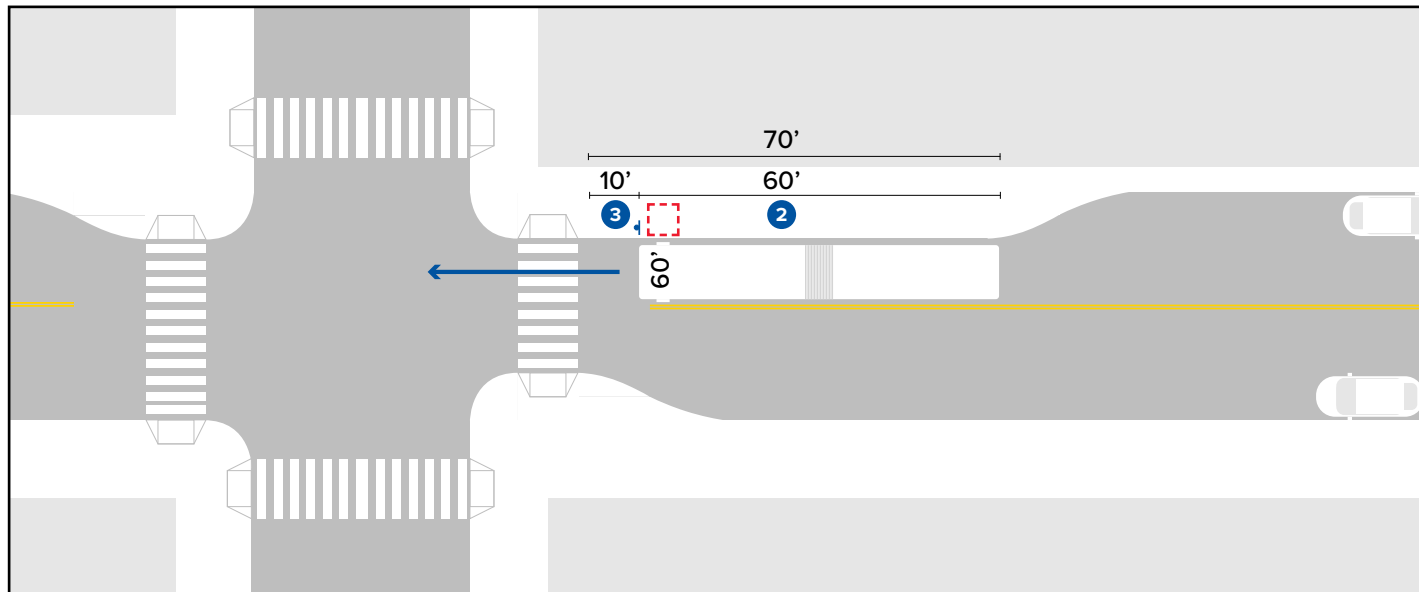

-  Accessible boarding area
-  1 Merge zone
-  2 Dwell zone
-  3 Setback from crosswalk
-  Bus stop sign
-  No parking sign

Bumpouts/curb extensions and bus stops

Pull-out bus stop before/after a bumpout

To locate a pull-out bus stop before or after a bumpout, designers should refer to a mid-block stop for bus stop vehicle zone lengths, with appropriate space to merge into and out of the curb lane, see Figure 45. If a pull-out stop would create a choke point on the sidewalk that is narrower than what is required for an accessible boarding area, 8', consider siting the stop in-lane, on the bumpout.

Advantages:

- For stops with longer than average dwell times or layover functions (stops that serve high schools, stops that serve a route terminal or relief location), a pull-out stop, before or after a bumpout, can serve bus operators and riders well by reducing vehicle queues behind the bus.
- Siting a bus stop before/after a bumpout may be appropriate for local service on corridors with METRO bus rapid transit service to keep BRT moving.

Disadvantages:

- Requires longer bus stop zone length than a bus stop located on a bumpout or pull-out bus stop not adjacent to a bumpout. The longer bus stop zone length also restricts on-street parking.
- Reduces bus speed and reliability by requiring buses to pull around bumpout before or after the intersection. Does not provide additional amenity space for riders as compared to stopping in-lane and on a bumpout.

Bumpouts/curb extensions and bus stops

Figure 45 Pull-out bus stop before/after a bumpout, shown for 40' and 60' buses

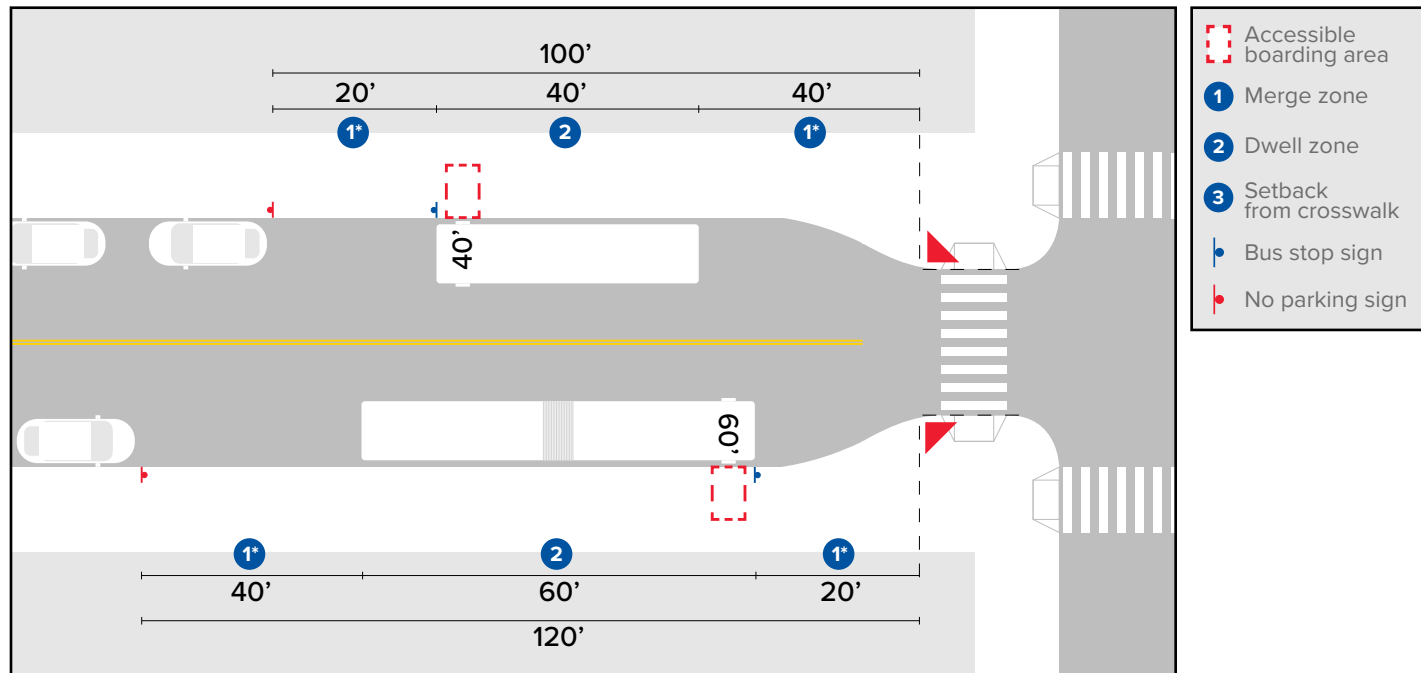

Bumpouts/curb extensions and bus stops

Bumpouts at non-bus stop corners only

Bumpouts can be sited at two of the four corners on a typical 4-leg intersection, leaving the bus stops on the other two corners as pull-out stops without bumpouts, see Figure 46.

Advantages:

- Allows buses to easily pull in and out of the bus stop zone, while providing bumpouts on other corners.
- May be appropriate for local service on corridors with METRO bus rapid transit service to keep BRT moving.

Disadvantages:

- Reduces bus speed and reliability by requiring buses to pull out of the travel lane and into a parking lane. Does not provide additional amenity space for riders as compared to stopping in-lane and on a bumpout.
- Compared to narrowing the intersection at all four corners, eliminating bumpouts at two corners does not reduce the crossing distance as much for people walking and rolling. Reducing the crossing distance increases safety for all modes.

Bumpouts/curb extensions and bus stops

Figure 46 Bumpouts at non-bus stop corners only

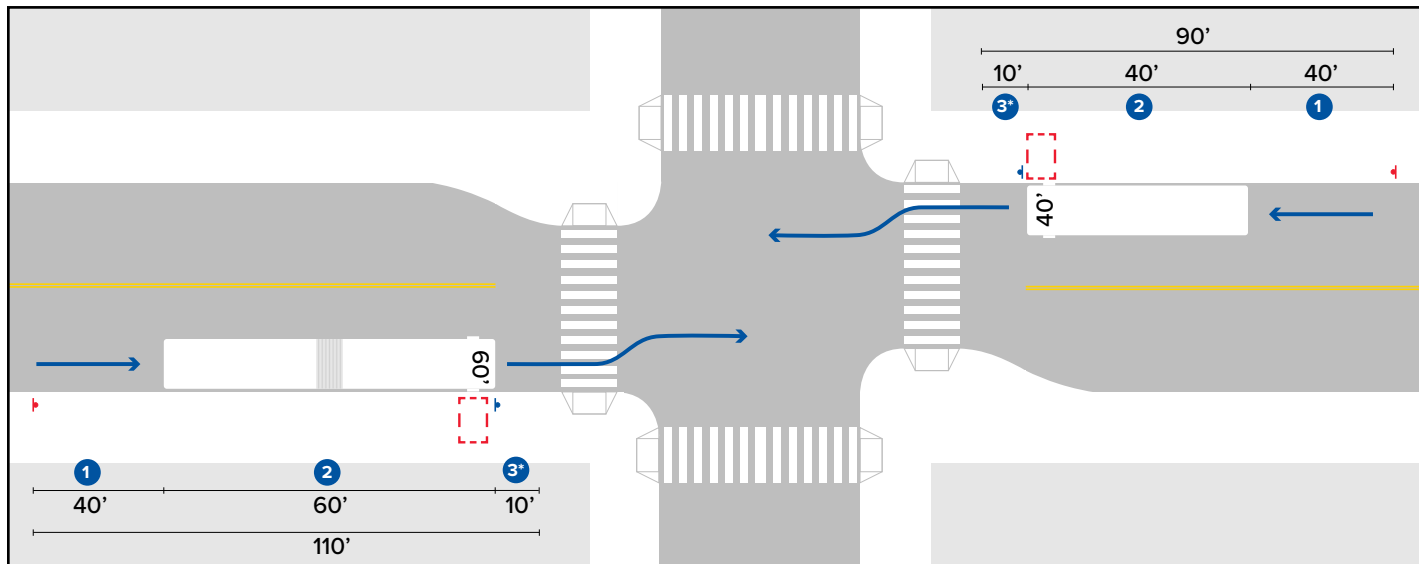

-  Accessible boarding area
-  1 Merge zone
-  2 Dwell zone
-  3+ Setback from crosswalk
-  Bus stop sign
-  No parking sign

Bus stops and bike facilities

Many cities and roadway authorities continue to implement a connected network of bike routes in Metro Transit's service area. Using a bike is one way transit riders can get from their origin/destination to the bus stop. Robust bike networks extend the reach of transit. Riders may either securely lock their bike at a transit stop or load their bike on the front rack of a bus. Designers can consider four different scenarios when bike facilities are proposed on a street with bus stops (or vice versa). Partnership between relevant roadway authorities and Metro Transit is important to achieve a successful design.

Figure 47 Bus stop and a bus bike mixing zone

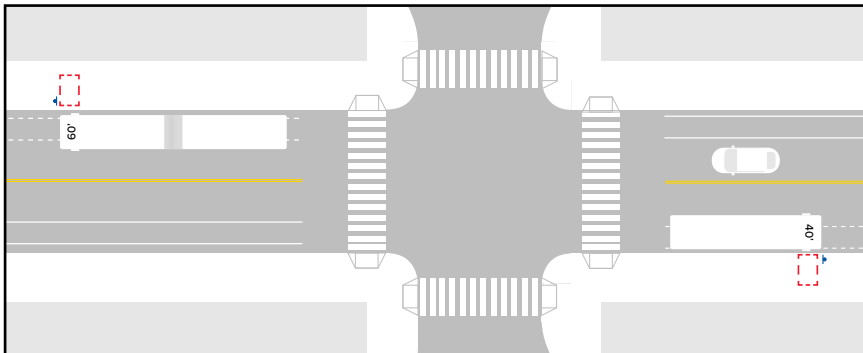

Figure 48 Example of a bus bike mixing zone on Chicago Ave. S. at E. 32nd St.



Source: Google Earth

Bus stops and bike facilities

Bus stop bike lane mixing zone

A bus stop bike lane mixing zone is a design where an on-street bike lane overlaps with the bus stop vehicle zone length, and buses must cross over the bike lane to merge into the curb, see Figure 47.¹⁶ This type of design is the most common case in Metro Transit's system where bike lanes coexist with bus routes and stops. Bikes do have to navigate space with buses and other vehicle traffic, but do not interact with transit passengers. Best practice includes striping the bike lane with dotted lines (or conflict markings such as green colored pavement) for the full bus stop zone where a bus crosses the bike lane to serve the stop, see Figure 47 and Figure 17 for total bus stop zone length by position.

Advantages:

- Consider levels of bus stop activity and people riding bikes. Bus stop bike lane mixing zones work best when volumes of either user are moderate or low.
- Bus stop bike lane mixing zones can fit in constrained contexts and can also be installed in retrofit projects.

Disadvantages:

- Buses, bikes and other motorized vehicles must navigate the combined space and yield appropriately.
- Separating modes maximizes safety. If moving the curb is part of project scope, consider other designs that produce more separation, such as a floating bus stop.

¹⁶ nacto.org/publication/transit-street-design-guide/stations-stops/stop-configurations/curbside-pull-stop/

Bus stops and bike facilities

Floating bus stop

A floating bus stop¹⁷ design channelizes the bike lane behind the clear zone of the bus stop, to maintain separate spaces for vehicles, people biking, and people boarding, alighting, and waiting for transit. Floating bus stops eliminate the interaction between buses and bicycles at the curb, and allow the bus to stop in-lane while maintaining physical bike lane protection and eliminating the need for a street-level mixing zone. While there are some examples of floating bus stops in the region, this type of bus stop facility is an emerging design.

¹⁷ Another name for floating bus stop is boarding island stop.

Figure 49 Floating bus stop

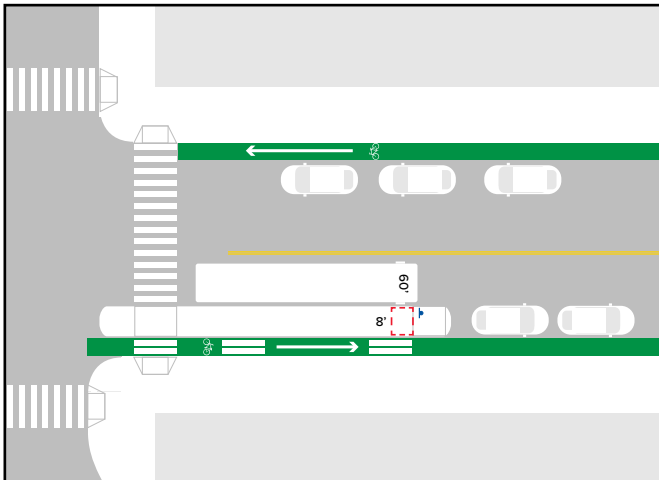

Figure 50 A floating bus stop on the University of Minnesota Twin Cities campus



Bus stops and bike facilities

Similar to an in-lane bus stop on a bumpout, designers must make the floating bus stop long enough to reach past the back door on buses that serve the stop, and a minimum width of 8' deep to achieve an accessible boarding area (more depth may be needed if siting a shelter or if the location is on a planned BRT corridor). Crossings or pedestrian mixing zones need to be included for transit riders to reach the accessible boarding area (multiple crossings are needed for busy bus stops/stations). Pedestrian crossings should consider sightlines and whether the bike facility is at street or sidewalk level. Design features to define the walking and biking spaces can include pavement markings, yield signs, detectable edges or warnings at crossings, tactile wayfinding along the bikeway, raising the bike facility to sidewalk level for the length of the bus stop, and on-board announcements.

Advantages:

- Floating bus stops allow buses to stop in-lane, preserve a separated bike facility, and expand available sidewalk space. This design eliminates interactions between buses and people on bikes. Separate space for different modes maximizes safety.
- Consider levels of bus stop activity and people riding bikes. Floating bus stops work best when volumes of either user are moderate or high.

Disadvantages:

- Requires crossings for transit riders to reach the accessible boarding area and increases interaction between people on bikes and people walking. Multiple crossings to the bus stop are required for busy bus stops.
- Installation of floating bus stops may be paired with a full roadway reconstruction project, where moving the curb is included in the project scope.

Bus stops and bike facilities

Shared bike-bus stop

A shared bike-bus stop (shared stop) is a design where the bike lane runs through the accessible boarding area and clear zone. Consider this design when a full floating bus stop is not feasible due to limited scope, right-of-way, or budget.

In this shared spaced, it is important to notify people on bikes to slow down, properly yield, and use caution when approaching.

Design features include:

- Conflict markings on bike lane
- Bikes Yield to Peds signage and pavement markings
- Detectable edges or warnings
- On-board announcements for alighting transit riders

One type of shared bike-bus stop in Metro Transit's service area includes bus stops sited on shared use paths, also known as sidepaths. As compared to exclusive bike facilities, shared use paths are two-way bicycle facilities that are physically separated from motor vehicle traffic and are usually found on one side of the roadway. As stated in Minnesota Department of Transportation's Bicycle Facility Design Manual, shared use paths can be within parkland, natural areas, or adjacent to roadways and are used by people both walking and biking.¹⁸

Figure 51 Shared bike-bus stop

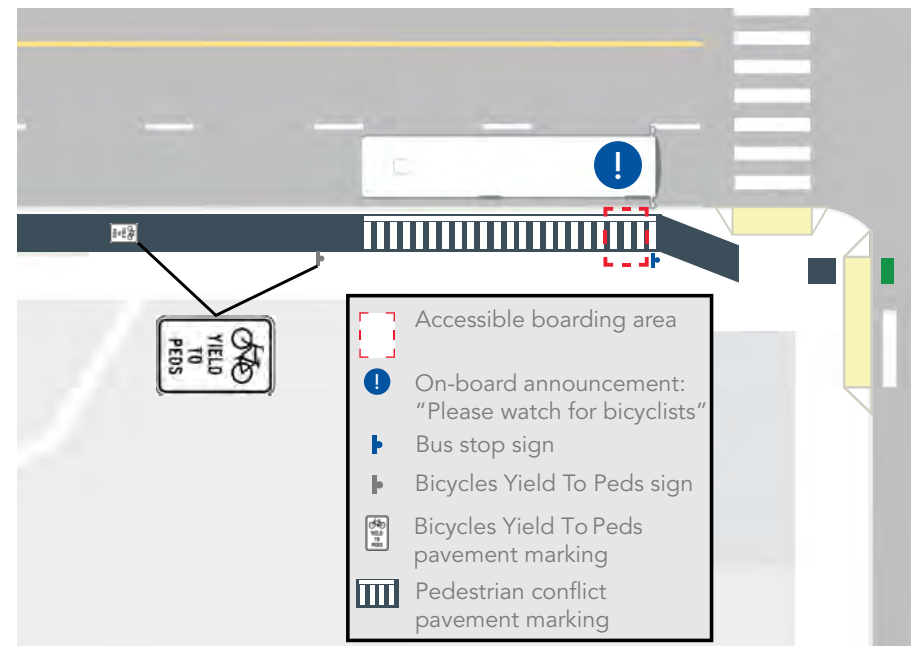

¹⁸ Minnesota Department of Transportation Bicycle Facility Design Manual (2020). dot.state.mn.us/bike/bicycle-facility-design-manual.html

Bus stops and bike facilities

Shared bike-bus stops work best when volumes of either user are moderate or low. Designers should consider pedestrian conflict pavement markings to highlight the accessible boarding area (where the ramp is deployed) and back door zones. See Figure 52 and Appendix D for a case study evaluation.

Advantages:

- Allows for bus stops in corridors with existing bike facilities.
- Eliminates the interaction between buses and people on bikes.

Disadvantages:

- Transit passengers must wait behind the bike lane, and then board and alight in the bike lane.
- This increases the interaction between people taking transit and people on bikes.
- Passengers getting off the bus must step out into a bike facility.

Figure 52 Shared bike-bus stop on Washington Ave at Marquette



Bus stops and bike facilities

Bike facility on another street

Occasionally, the right-of-way is constrained enough that the roadway authority may choose to site a bike facility on an adjacent street to better serve street users.

Things to consider:

- Connectivity of the transit and bike networks.
- Levels of existing or potential bus stop activity and people riding bikes.
- Whether moving the curb is part of project scope.

Pull-out bays on high speed roads

Pull-out bays are a type of bus stop design for high speed roadways, or special circumstances with layover functions (route terminal or relief location). It is constructed as an inset into the curb, typically with tapered ends for acceleration and deceleration. Pull-out bay stops allow the buses to maneuver to the edge of the roadway without impeding traffic flow. This design requires enough right-of-way so that sidewalk space is not adversely affected and is generally discouraged in urban areas with lower speed limits. A closed bay pull-out stop (tapers on either end) is shown in Figure 53, and an open bay pull-out stop (taper on one end) is shown in Figure 54.

An acceleration/deceleration analysis for a pull-out bay on high speed roadways is included in Appendix A, however, designers should work with the roadway authority's traffic and geometrics engineers to design the bus stop. In some cases, the dimensions in the analysis have resulted in a bus stop design that is too conservative.

Pull-out bays on high speed roads

Figure 53 Closed bay pull-out stop for high speed roadways

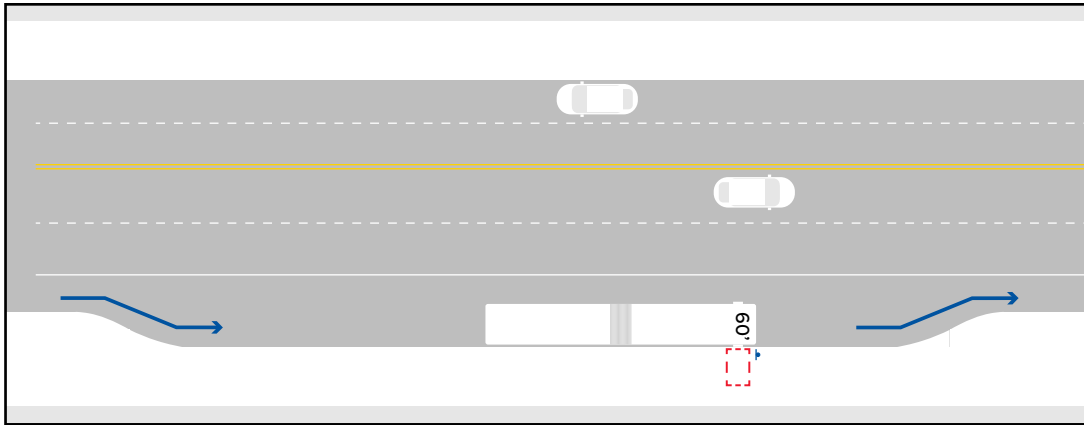
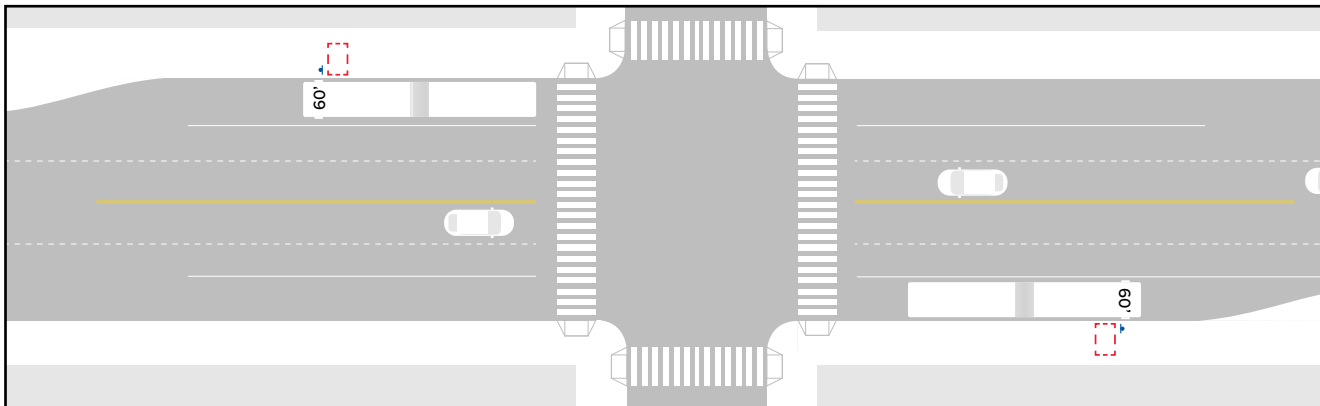

Figure 54 Open bay pull-out stop for high speed roadways



Topics for future study

These topics are not addressed here but are being researched and developed for a future update to this Guide.

- Bus stop design at roundabouts
- Bus stop design for 3-lane roadways
- Hardened centerlines near bus stops
- Temporary bus stops and Temporary Pedestrian Access Route (TPAR)

Appendix A: Summary Technical Specs

Figure 55 Verify which signs and transit poster inserts are needed with Metro Transit Transit Information

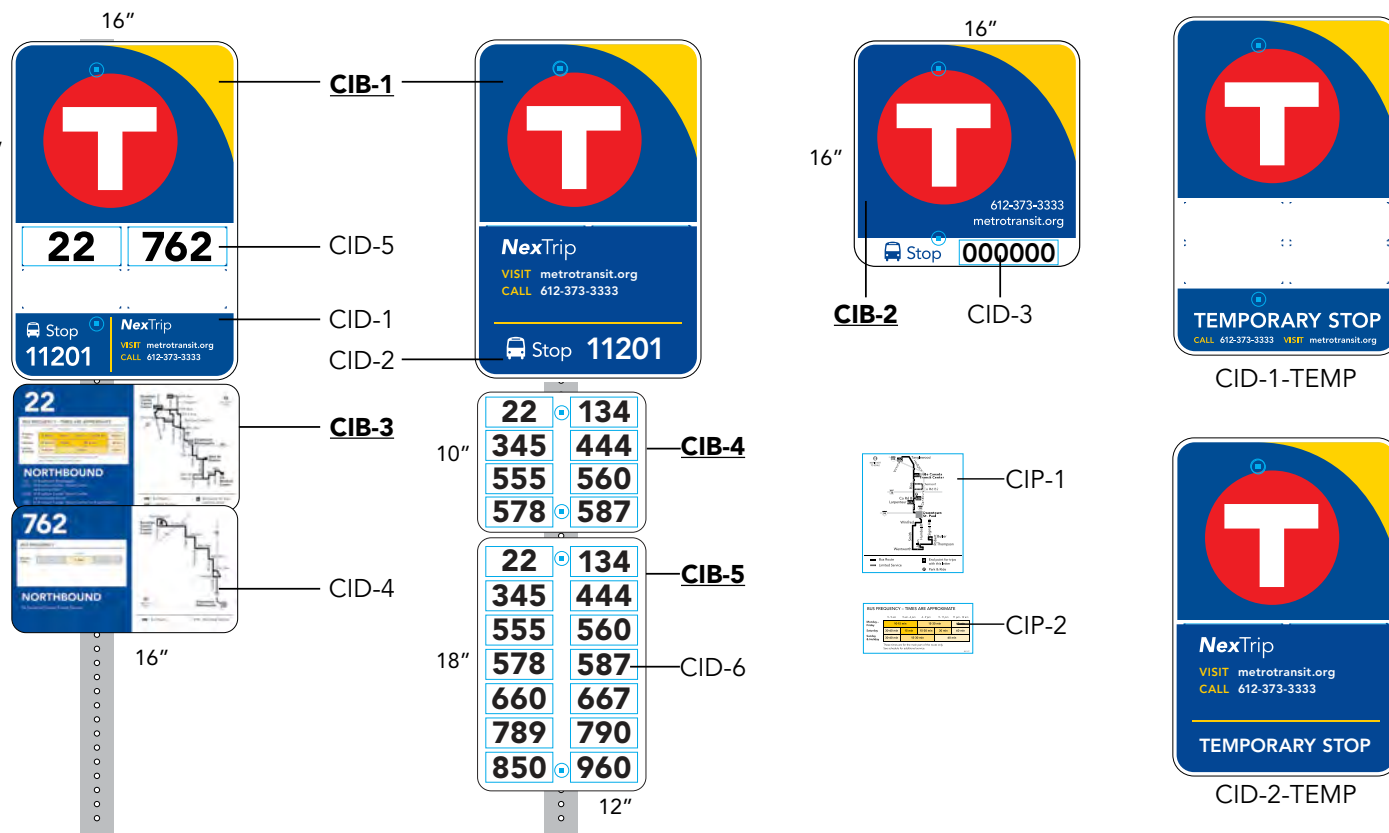

Appendix A: Summary Technical Specs

Figure 56 PDF image of the Metro Transit standard bus stop sign CAD file¹

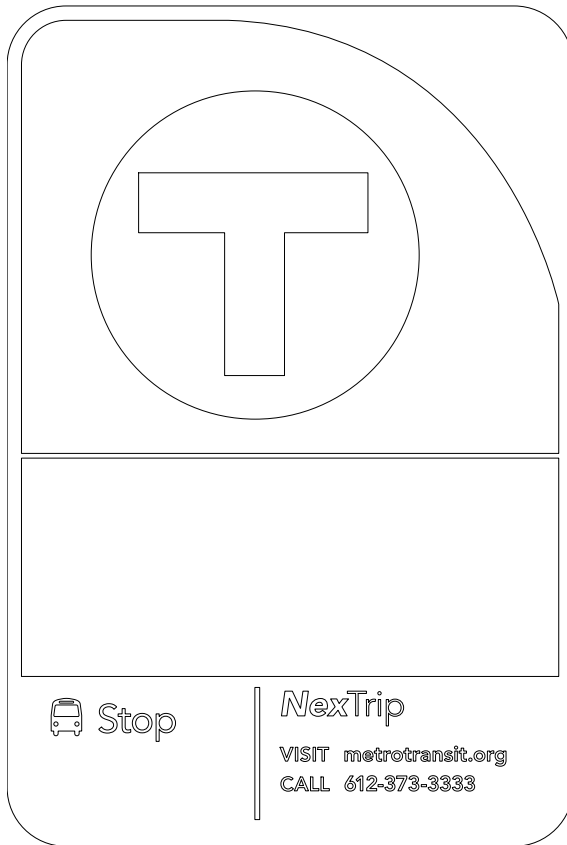

¹ metrotransit.org/shelter-design

Appendix A: Summary Technical Specs

Figure 57 Clear zones with 3-door and MCI buses

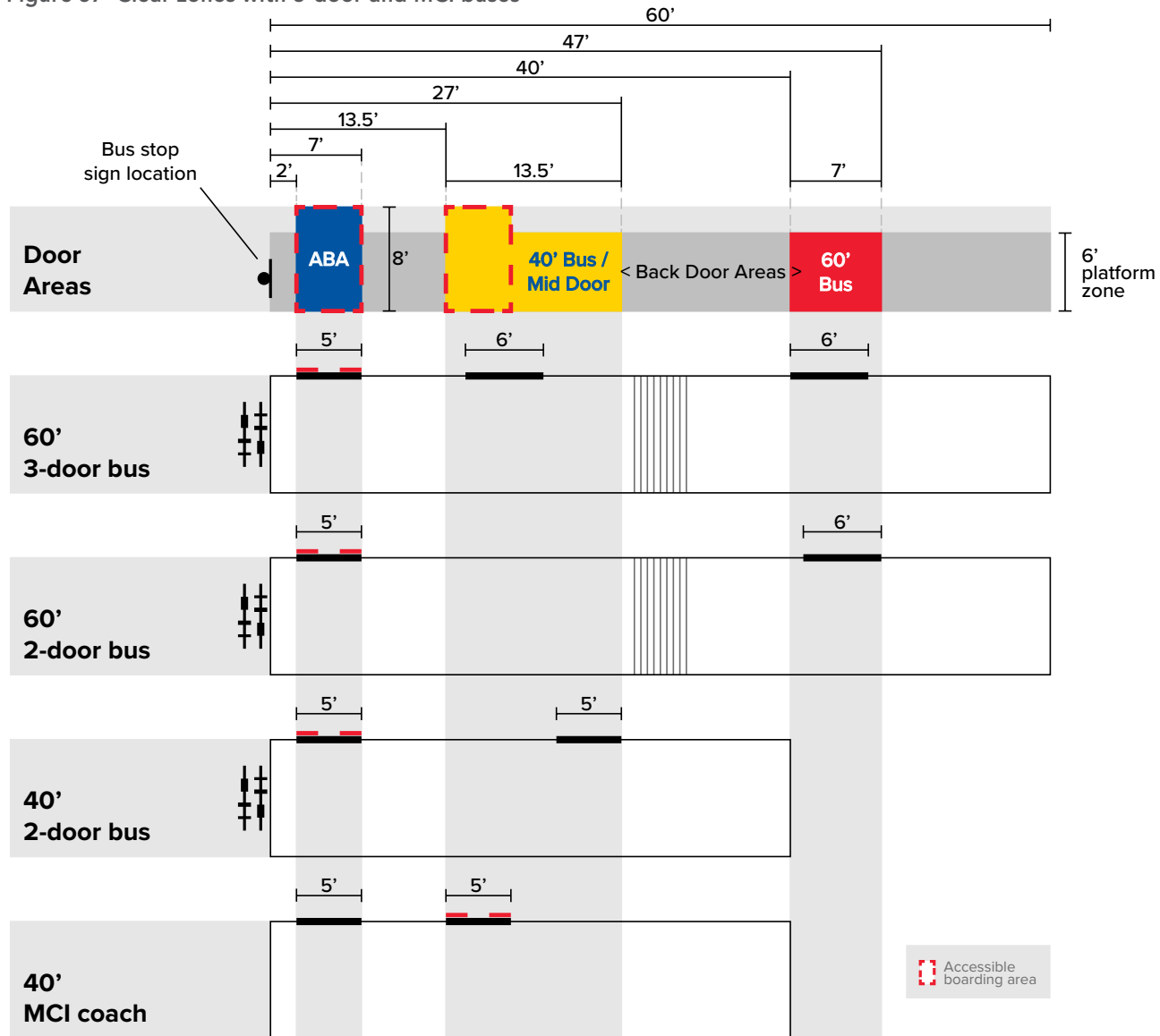

Appendix A: Summary Technical Specs

Figure 58 Corner number system for far side, near side, and mid-block bus stops.

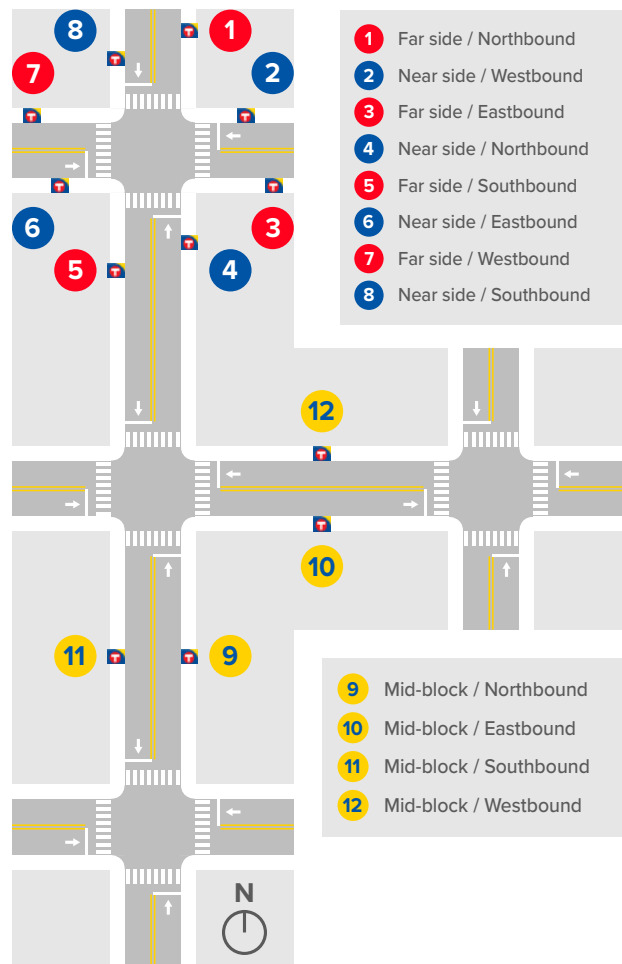

Appendix A: Summary Technical Specs

Figure 59 Corner number system for across from bus stops.

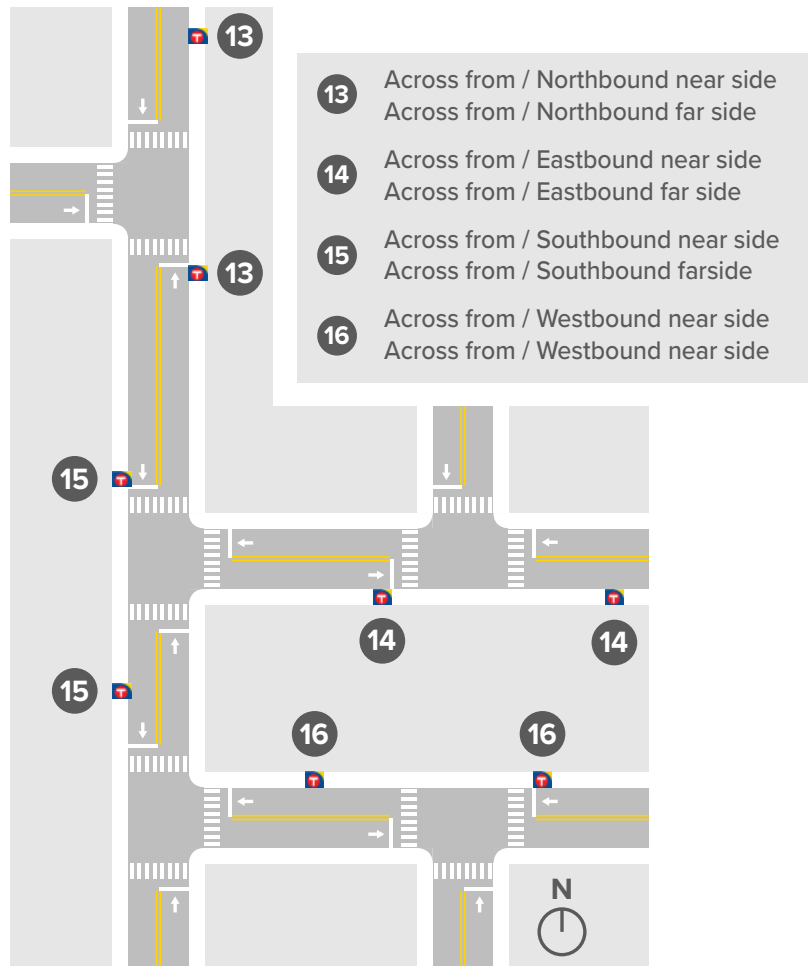

Appendix A: Summary Technical Specs

Figure 60 An accessible boarding area concrete pad installation in a grass boulevard with room for an advertisement bench.

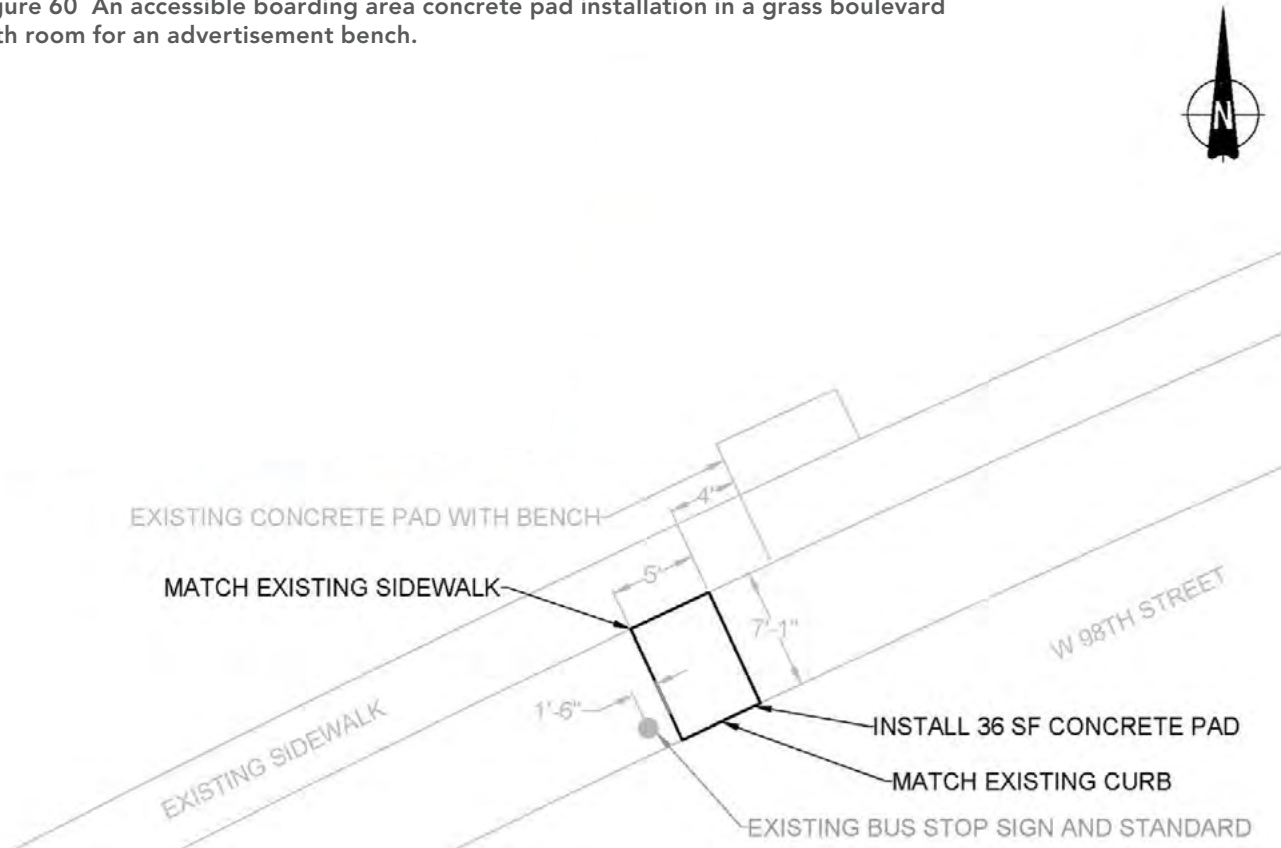

Appendix A: Summary Technical Specs

Figure 61 An accessible boarding area (ADA pad) concrete pad installation to connect the sidewalk to the curb over a wide boulevard.

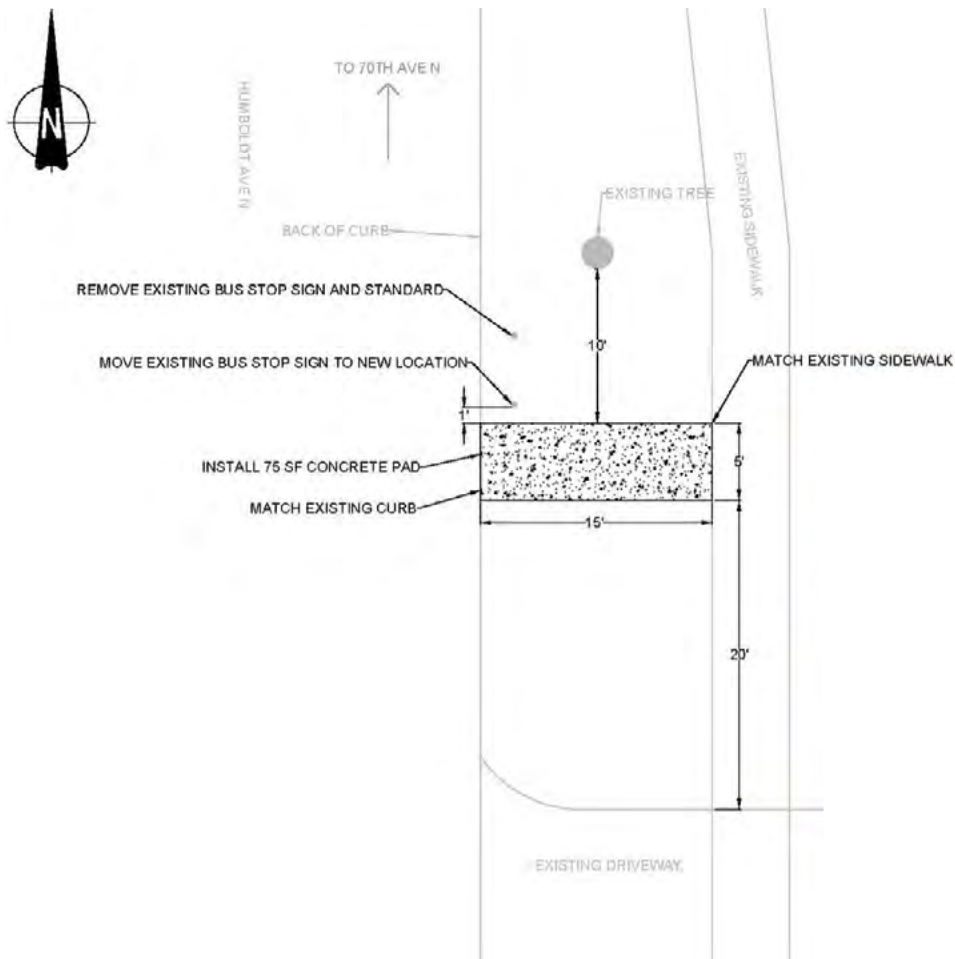

Appendix A: Summary Technical Specs

Figure 62 An accessible boarding area concrete pad installation requiring a sidewalk. In this situation, the nearest existing sidewalk was approximately 25' from the bus stop location.

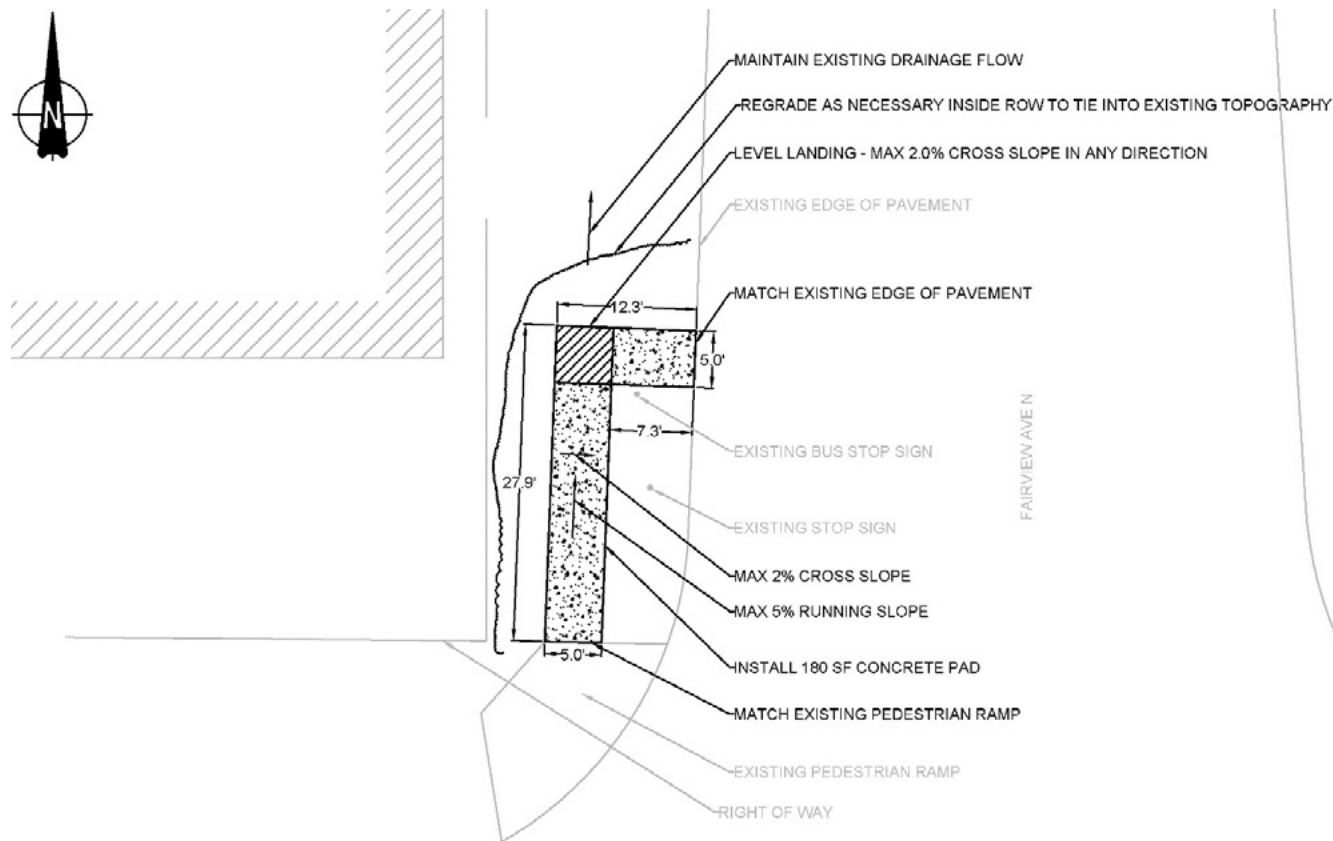

Appendix A: Summary Technical Specs

Figure 63 Acceleration/deceleration analysis for a pull-out bay

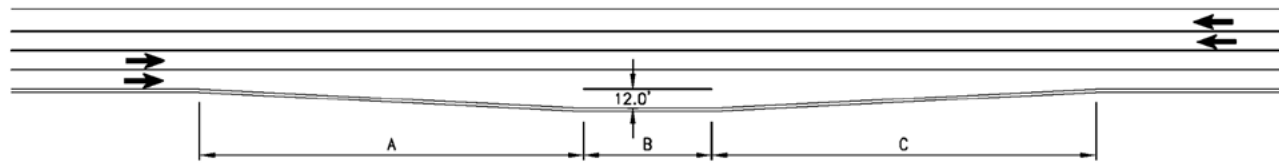

DESIGN SPEED (MPH)	PERCEPTION /REACTION DISTANCE (FT)	BREAKING DISTANCE (FT)	STOPPING SIGHT DISTANCE		ACCELERATING DISTANCE DESIGN (FT) (C)
			CALCULATED (FT)	DESIGN (FT) (A)	
30	110.3	86.4	196.7	200	310
35	128.6	117.6	246.2	250	440
40	147	153.6	300.6	305	600
45	164.4	194.6	359	360	790
50	183.8	240	423.8	425	990
55	202.1	290.3	492.4	495	1220
60	220.5	345.5	566	570	1500

BUS TYPE	B FT
BUS-40	60
BUS-60	80

Assume Deceleration rate at 11.2 ft/s²

Assume Acceleration rate at 2.2 ft/s²

Appendix B: Glossary of terms

- **40' bus:** A bus that is 40' long. These buses are the most common in Metro Transit's fleet.
- **60' bus:** A bus that is 60' long and holds more people than a 40' bus. These buses have the bendable middle segment and are sometimes known as articulated buses or "accordion buses."
- **Accessible boarding area (ADA pad or ABA):** The place where passengers get on and off the bus at the front door, directly adjacent to the bus stop sign. This is also where the bus operators deploy the ramp for passengers using mobility devices. The area is a firm and stable surface, and shall provide a clear length of 96 in. (8'), measured perpendicular to the curb or vehicle roadway edge, and a clear width of 60 in. (5') minimum, measured parallel to the vehicle roadway, as stated in 810 Transportation Facilities chapter of the 2010 ADA Standards for Accessible Design.
- **Across from:** bus stop at a T-intersection (3-leg). Can be near side or far side.
- **Alight:** To get off or out of a transportation vehicle.
- **Board:** To get on or into a transportation vehicle.
- **Bumpout/curb extension:** A curb bumpout is a strategy to improve safety for all road users, by extending the curb at a corner and narrowing the roadway width at intersections.
- **Bus stop bike lane mixing zone:** A bike-bus stop zone is a design where the bike lane is at street level, the bike lane overlaps with the bus stop merging zone, and bikes do not interact with transit passengers.
- **Bus stop zone:** The bus stop zone encompasses all elements of the bus stop, describing the bus stop vehicle zone, in the street, and the bus stop clear zone, behind the curb.
- **Bus stop:** A location marked with site specific signs, indicating where buses will stop.
- **Clear zone:** The clear zone, behind the curb, is where transit riders wait, queue, board, and alight the bus. The clear zone is 6' deep min., and includes the bus stop sign, accessible boarding area, space for a bus shelter, and other streetscape amenities.
- **Closed bay pull-out bus stop:** A closed-bay pull-out stop is a design for high speed roadways, or special circumstances, and has tapers on both ends.

Appendix B: Glossary of terms

- **Dwell zone:** The dwell zone is the space, in the street, needed for a transit vehicle to stop at the curb, or edge of roadway, and perform dwell functions: rider boarding and alighting, fare collection, etc.
- **Far side:** bus stop located after the intersection (in the direction of travel).
- **Floating bus stop:** A floating bus stop design channelizes the bike lane behind the clear zone of the bus stop, to maintain separate spaces for people biking and people boarding, alighting, and waiting for transit.
- **In-lane stop:** Bus stop located in a travel lane, allowing the bus to serve the stop and continue the route without having to merge out and then back into the travel lane.
- **Merge zone:** The merge zone is the space, in the street, needed to maneuver into and out of a curb lane at a pull-out stop, often denoted by the no parking sign.
- **Mid-block:** bus stop not located adjacent to an intersection.
- **Minnesota Accessibility Code (2015):** Code to establish minimum requirement to safeguard the public health, safety and general welfare through structural strength, means of egress facilities, stability, sanitation, adequate light and ventilation, energy conservation, and safety to life and property from hazards attributed to the built environment.
- **Near side:** bus stop located before the intersection (in the direction of travel).
- **Open bay pull-out bus stop:** An open-bay pull-out stop is a design for high speed roadways, or special circumstances, and has tapers on one end.
- **Pedestrian Access Route (PAR):** A continuous, and clear path with width of 4.0' minimum, exclusive of the width of the curb, as stated in Chapter 4 Accessible Routes, Sections 402 and 403, of the Minnesota Accessibility Code (2015), and Chapter R3 Technical Requirements of the Proposed Accessibility Guidelines for Pedestrian Facilities in the Public Right-of-Way 2011 (PROWAG). The PAR connects the bus stop to destinations.

Appendix B: Glossary of terms

- **Proposed Accessibility Guidelines for Pedestrian Facilities in the Public Right-of-Way 2011 (PROWAG):** Recommended guidelines for designing and constructing facilities within the public rights of way, most recently released in 2011, as a best practice for accessibility issues in the public right of way not covered by the Department of Justice’s currently adopted standards.
- **Pull-out stop:** Bus stop located in a curbside lane (usually a parking lane or pull-out bay, signed as a bus stop), requiring the bus to merge out of and back into the travel lane in order to serve the stop.
- **Setback from crosswalk:** The setback from crosswalk is a 10’ distance between the dwell zone and a marked or unmarked crossing to preserve sightlines between people in vehicles and people walking.
- **Shared bike-bus stop:** A shared bike-bus stop is a design solution aiming to maintain a high-quality bike facility at bus stop locations where a full floating bus stop is not feasible due to limited right-of-way or project costs.
- **United States Access Board 2010 ADA Standards for Accessible Design:** The US Access Board is a federal agency that promotes equality and inclusion of people with disabilities by creating accessibility guidelines and standards for the built environment, transit vehicles, telecommunications equipment, medical diagnostic equipment, and information technology. The most recent federal standard is the 2010 ADA Standards for Accessible Design, which sets the minimum requirements – both scoping and technical for newly designed and constructed or altered State and local government facilities, public accommodations, and commercial facilities to be readily accessible to and usable by individuals with disabilities.

Appendix C: Merge zone field test

In September 2020, a field test was conducted by Engineering & Facilities and Street Operations, with the goal to combine professional expertise, AutoTurn analysis, and field testing to confirm the square required for the merge zone. Using simulated near side and far side stops near Heywood Garage, the team tested 40' and 60' buses to arrive at the recommended lengths.

A near side bus stop was simulated on N. 8th Ave. and N. 5th St. using the street and intersection. A far side bus stop was simulated using a Heywood Garage driveway on N. 8th Ave. as an intersection, see Figure 65.

Prior to the field test, the near side and far side bus stops were marked using a traffic cone with paper bus stop sign, survey wheel, and tape to distances in increments of 5'.

Figure 64 Simulated bus stops outside Heywood Garage



Source: Google Earth

Figure 65 Measurements on sidewalk



Appendix C: Merge zone field test

Overall, bus operators were able to maneuver the bus expertly in constrained scenarios. The scenarios tested in the field added nuance and confirmed the merge lengths. For instance, some maneuvers were able to be made, such as a near side 40' bus with a 30' merge zone, but it was recommended for limited applicability, and should not be a length on which to base design standards.

Figure 66 shows scenarios tested for both a 40' bus and 60' bus pulling into a simulated near side stop. The yellow highlighted and bolded rows show the recommended bus stop vehicle zone lengths for the design guide.

Figure 66 Summary of near side scenarios tested

#	STOP POSITION	DWELL ZONE / BUS SIZE (FT)	MERGE IN ZONE (FT)	TOTAL BUS STOP VEHICLE ZONE** (FT)	OUTCOME
1	Near side	40	50	100	Success
2	Near side	40	40	90	Success
3	Near side	40	30	80	Limited applicability
4	Near side	40	25	75	Fail
5	Near side	60	50	120	Success
6	Near side	60	40	110	Success
7	Near side	60	30	100	Success*
8	Near side	60	20	90	Fail

*While the merge zone test of 30' in length using a 60' bus was successful, it was decided that it may not be successful during winter conditions.

**This table does not include the 10' setback from crosswalk. However, if these stops were implemented, they would use the Total Bus Stop Vehicle Zone (FT) value, which includes the 10' setback from crosswalk. That is why the sum of the dwell zone and the merge zone is 10' less than the total bus stop vehicle zone.

Appendix C: Merge zone field test

Figure 67 shows scenarios tested on a simulated far side stop with both 40' and 60' buses. The merge zone being tested is pulling out of the bus stop.

Figure 67 Summary of far side scenarios tested

#	STOP POSITION	DWELL ZONE / BUS SIZE (FT)	MERGE IN ZONE (FT)	TOTAL BUS STOP VEHICLE ZONE** (FT)	OUTCOME
1	Far side	40	25	75	Success
2	Far side	40	20	70	Success
3	Far side	40	15	65	Success*
4	Far side	40	10	60	Not recommended
5	Far side	60	25	95	Success
6	Far side	60	20	90	Success
7	Far side	60	15	85	Not recommended
8	Far side	60	10	80	Fail

*While the merge zone test of 15' in length using a 40' bus was successful, it was decided that it may not be successful during winter conditions.

**This table does not include the 10' setback from crosswalk. However, if these stops were implemented, they would use the Total Bus Stop Vehicle Zone (FT) value, which includes the 10' setback from crosswalk. That is why the sum of the dwell zone and the merge zone is 10' less than the total bus stop vehicle zone.

Appendix C: Merge zone field test

Figure 68 Screenshots showing a 60' bus testing a 40' merge zone a near side stop and a 60' bus testing a 40' merge zone at a far side stop

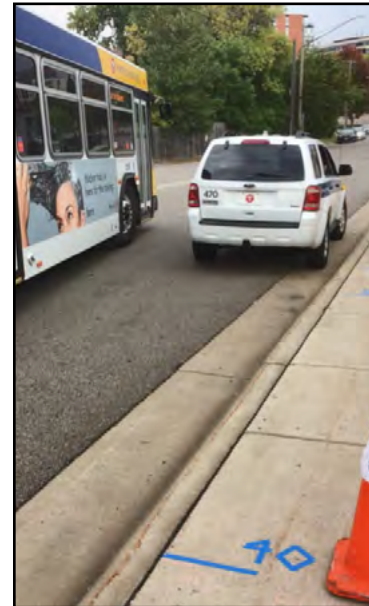

Appendix C: Merge zone field test

Figures 69 and 70 show two instances where the merge zone tested was too short and the outcome was failure.

Figure 69 shows a 60' bus testing a 20' merge zone and 10' setback from crosswalk for a total of 90' of bus stop vehicle zone length for a near side stop. This test resulted in the tail of the bus sticking out into the travel lane (potentially blocking other vehicles), and the back door situated too far from the curb, resulting in failure. The design standard for a 60' bus in a near side, pull-out stop is 110', see Figure 17.

Figure 70 shows a 60' bus testing a 10' merge zone and 10' setback from crosswalk for a total of 80' of bus stop vehicle zone length for a far side stop. This test resulted in the bus not being able to pull around a parked car without contact, resulting in failure. The design standard for a 60' bus in a far side, pull-out stop is 90', see Figure 17.

Figure 69 Screenshot showing a 60' bus testing a 20' merge zone (too short) for a near side stop and failing



Figure 70 Screenshot showing a 60' bus testing a 10' merge zone (too short) for a far side stop and failing



Appendix D: Shared stop case study

Case Study: Shared Stop at Washington Avenue and Marquette Avenue

Through the Better Bus Route 3 program, a new bus stop pair was needed at Washington Avenue and Marquette Avenue in downtown Minneapolis (Transit Market Area 1) where an existing back of curb bike facility exists. A shared stop pair was piloted in November 2021 and an evaluation was conducted in Fall 2022. The findings determined that these stops are operating successfully and the design is recommended for similar contexts.

Staff observed the stops over 7.5 hours on typical weekdays and collected data. Route 3 trips generally followed scheduled 10-15 minute headways (4-6 trips/hour) during AM and PM rush hours and 15 minute headways (4 trips/hour) midday. Observation showed minimal interaction between people on bikes and transit riders, no near misses, and no crashes.

Figure 71 Shared bike-bus stop plans for Washington Ave at Marquette

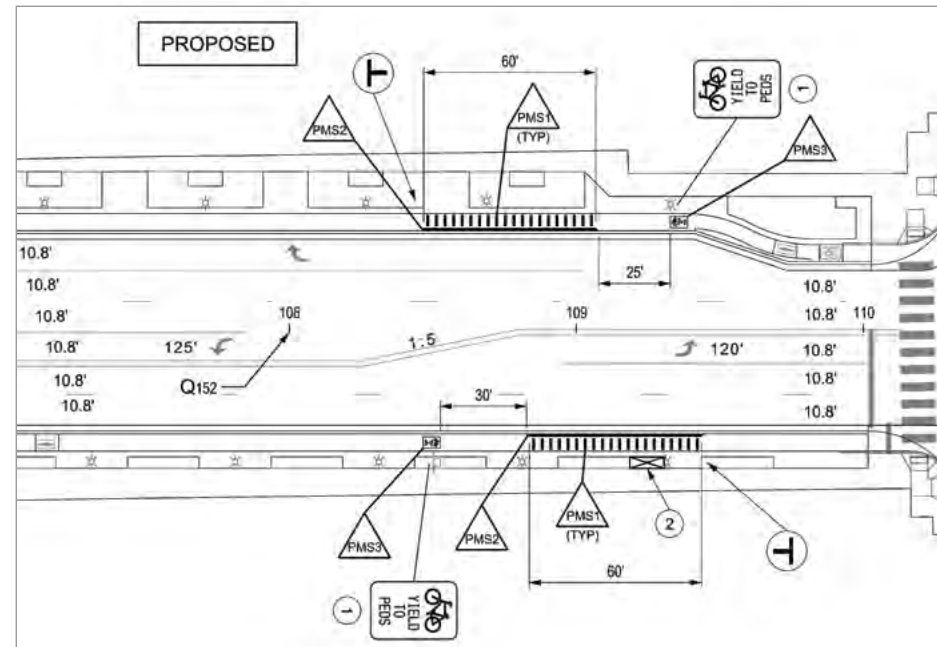

Appendix D: Shared stop case study

Sightlines at these stops are unobstructed, the approach is flat, and signals are closely spaced (~400'), so most people on bikes aren't traveling very fast. Nearly all bikes appropriately yielded and approached with an abundance of caution if transit riders were nearby.

Almost all riders waiting to board transit at the eastbound stop were waiting in the landscaping zone/shelter or on the sidewalk. The mixing zone or "crosswalk" pavement marking was important for riders getting off the bus, see Figures 72 and 73.

During the pilot observation period (Nov. 2021 - Sept. 2022) no incidents or complaints were recorded in Metro Transit's data. Additionally, no incidents were recorded in Hennepin County data.

Figure 72 Observational volume of transit riders (ons + offs) and people on bikes

	EASTBOUND STOPS	WESTBOUND STOPS
Transit Riders (total)	83	55
Transit Riders (ave. per hour)	11	7
People on Bikes (total)	130	117
People on Bikes (ave. per hour)	17	16

Figure 73 Shared bike-bus stop on Washington Ave at Marquette, labeling the bike facility, landscaping zone/shelter, and sidewalk.





METRO TRANSIT

560 Sixth Avenue North

Minneapolis, MN 55411

612-373-3333

metrotransit.org

Sonja Burseth, AICP

sonja.burseth@metrotransit.org

Engineering and Facilities